

JVC®

GY-HD100/GY-HD101 HD CAMERA RECORDER

HD CAMERA RECORDER

GY-HD100

INSTRUCTIONS

GY-HD101

HDV Mini DV

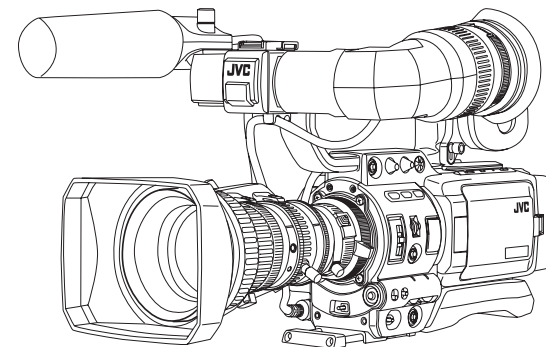

Thank you for purchasing this JVC product. Before operating this unit, please read the instructions carefully to ensure the best possible performance.

For Customer Use :

Enter below the Serial No. which is located on the body.
Retain this information for future reference.
Model No.
Serial No.

* The illustration shows the GY-HD100/GY-HD101 HD CAMERA RECORDER with the provided lens, viewfinder, Microphone and battery pack attached.

E

INTRODUCTION

CONTROLS,
INDICATORS AND
CONNECTORS

PREPARATIONS

PREPARATIONS
FOR OPERATION

SETTING AND
ADJUSTMENTS
BEFORE SHOOTING

SHOOTING
OPERATION

PLAYBACK MODE

USING EXTERNAL
COMPONENTS

MENU SCREENS

FEATURES OF THE
CAMERA SECTION

OTHERS

JVC®

JVC® is a registered trademark owned by Victor Company of Japan, Limited
JVC® is a registered trademark in Japan, the U.S.A., the U.K. and many other countries.
© 2005 Victor Company of Japan, Limited

Printed in Thailand
LWT0278

LWT0278

Important Safety Instructions

1. Read all of these instructions.
2. Keep these instructions.
3. Heed all warnings.
4. Follow all instructions.
5. Do not use this apparatus near water.
6. Clean only with dry cloth.
7. Do not block any ventilation openings. Install in accordance with the manufacturer's instructions.
8. Do not install near any heat sources such as radiators, heat resistors, stoves, or other apparatus (including amplifiers) that produce heat.
9. Do not defeat the safety purpose of the polarized or grounding-type plug. A polarized plug has two blades with one wider than the other. A grounding type plug has two blades and a third grounding prong. The wide blade or the third prong are provided for your safety. If the provided plug does not fit into your outlet, consult an electrician for replacement of the obsolete outlet.
10. Protect the power cord from being walked on or pinched particularly at plug, convenience receptacles, and the point where they exit from the apparatus.
11. Only use attachments/accessories specified by the manufacturer.
12. Use only with the cart, stand, tripod, bracket, or table specified by the manufacturer, or sold with the apparatus. When a cart is used, use caution when moving the cart/apparatus combination to avoid injury tip-over.
13. Unplug this apparatus during lightning storms or when unused for long periods of time.
14. Refer all servicing to qualified service personnel. Servicing is required when the apparatus has been damaged in any way, such as power-supply cord or plug id damaged, liquid has been spilled objects have fallen into the apparatus, the apparatus has been exposed to rain or moisture, does not operate normally, or has been dropped.

PORTABLE CART WARNING
Symbol provided by IETACI



S3125A

Important Safety Instructions

FOR USA AND CANADA

CAUTION

RISK OF ELECTRIC SHOCK
DO NOT OPEN

CAUTION: TO REDUCE THE RISK OF ELECTRIC SHOCK, DO NOT REMOVE COVER (OR BACK). NO USER SERVICEABLE PARTS INSIDE. REFER SERVICING TO QUALIFIED SERVICE PERSONNEL.

The lightning flash with arrowhead symbol, within an equilateral triangle is intended to alert the user to the presence of uninsulated "dangerous voltage" within the product's enclosure that may be of sufficient magnitude to constitute a risk of electric shock to persons.

The exclamation point within an equilateral triangle is intended to alert the user to the presence of important operating and maintenance (servicing) instructions in the literature accompanying the appliance.

INFORMATION FOR USA

INFORMATION:
This equipment has been tested and found to comply with the limits for a Class B digital device, pursuant to Part 15 of the FCC Rules.
These limits are designed to provide reasonable protection against harmful interference in a residential installation. This equipment generates, uses, and can radiate radio frequency energy and, if not installed and used in accordance with the instructions, may cause harmful interference to radio communications. However, there is no guarantee that interference will not occur in a particular installation.
If this equipment does cause harmful interference to radio or television reception, which can be determined by turning the equipment off and on, the user is encouraged to try to correct the interference by one or more of the following measures:

- Reorient or relocate the receiving antenna.
- Increase the separation between the equipment and receiver.
- Connect the equipment into an outlet on a circuit different from that to which the receiver is connected.
- Consult the dealer or an experienced radio/TV technician for help.

CAUTION:
CHANGES OR MODIFICATIONS NOT APPROVED BY JVC COULD VOID USER'S AUTHORITY TO OPERATE THE EQUIPMENT.

THIS DEVICE COMPLIES WITH PART 15 OF THE FCC RULES. OPERATION IS SUBJECT TO THE FOLLOWING TWO CONDITIONS: (1) THIS DEVICE MAY NOT CAUSE HARMFUL INTERFERENCE, AND (2) THIS DEVICE MUST ACCEPT ANY INTERFERENCE RECEIVED, INCLUDING INTERFERENCE THAT MAY CAUSE UNDESIRE OPERATION.

INFORMATION (FOR CANADA) RENSEIGNEMENT (POUR CANADA)

This Class B digital apparatus complies with Canadian ICES-003.
Cet appareil numérique de la Class B est conforme à la norme NMB-003 du Canada.

WARNING:
TO REDUCE THE RISK OF FIRE OR ELECTRIC SHOCK, DO NOT EXPOSE THIS APPLIANCE TO RAIN OR MOISTURE.
This unit should be used with 7V DC only.
CAUTION:
To prevent electric shocks and fire hazards, do NOT use any other power source.

NOTE:
The rating plate (serial number plate) is on the bottom of the unit.

CAUTION:
To prevent electric shock, do not open the cabinet. No user serviceable parts inside. Refer servicing to qualified service personnel.

AVERTISSEMENT :
POUR EVITER LES RISQUES D'INCENDIE OU D'ELECTROCUTION, NE PAS EXPOSER L'APPAREIL A L'HUMIDITE OU A LA PLUIE.
Ce magnéscope ne doit être utilisé que sur du courant direct en 7V.
ATTENTION :
Afin d'éviter tout risque d'incendie ou d'électrocution, ne pas utiliser d'autres sources d'alimentation électrique.

REMARQUE:
La plaque signalétique (plaque du numéro désirée) est située sur le cadre inférieur de l'unité.

Due to design modifications, data given in this instruction book are subject to possible change without prior notice.

The apparatus shall not be exposed to dripping or splashing and that no objects filled with liquids, such as vases, shall be placed close to the apparatus.

Worded - "CAUTION - Danger of explosion if battery is incorrectly replaced. Replace only with the same or equivalent type."

Important Safety Instructions

FOR EUROPE

This equipment is in conformity with the provisions and protection requirements of the corresponding European Directives. This equipment is designed for professional video appliances and can be used in the following environments:

- residential area (in houses)
- commercial and light industry; e.g. offices or theatres
- urban outdoors

In order to keep the best performance and furthermore for electromagnetic compatibility we recommend to use cables not exceeding the following length:

Camera

Port	Cable	Length
DC IN	Exclusive Cable	2 m
INPUT 1/2	Shielded Cable	3 m
LINE OUTPUT	Shielded Cable	1.5 m
PHONES 1/2	Shielded Cable	2 m
VIDEO/Y,PB,PR	Shielded Cable	3 m
IEEE1394 (HDV/IV)	Exclusive Cable	4.5 m

AC ADAPTER

Port	Cable	Length
DC OUT	Exclusive Cable	2 m
AC IN	Exclusive Cable	2 m

The inrush current of the apparatus is 7 amperes.
Caution: Where there are strong electromagnetic waves or magnetism, for example near a radio or TV transmitter, transformer, motor, etc., the picture and the sound may be disturbed. In such case, please keep the apparatus away from the sources of the disturbance.

WARNING:
TO REDUCE THE RISK OF FIRE OR ELECTRIC SHOCK, DO NOT EXPOSE THIS APPLIANCE TO RAIN OR MOISTURE.
This unit should be used with 7V DC only.
CAUTION:
To prevent electric shocks and fire hazards, do NOT use any other power source.

NOTE:
The rating plate (serial number plate) is on the bottom of the unit.

CAUTION:
To prevent electric shock, do not open the cabinet. No user serviceable parts inside. Refer servicing to qualified service personnel.

Due to design modifications, data given in this instruction book are subject to possible change without prior notice.

The apparatus shall not be exposed to dripping or splashing and that no objects filled with liquids, such as vases, shall be placed close to the apparatus.

Worded - "CAUTION - Danger of explosion if battery is incorrectly replaced. Replace only with the same or equivalent type."

Caution for AC Mains Lead FOR YOUR SAFETY PLEASE READ THE FOLLOWING TEXT CAREFULLY.

Appropriate mains cable must be used in each local area, since the other type of mains cable is not suitable.

FOR CONTINENTAL EUROPE, ETC.

Not to be used in the U.K.

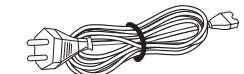

FOR U.K. ONLY

If the plug supplied is not suitable for your socket outlet, it should be cut off and appropriate one fitted.

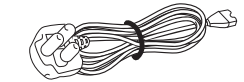

Thank you for purchasing the JVC GY-HD100U, GY-HD100E and GY-HD101E HD CAMERA RECORDER.

These instructions are for the GY-HD100U, GY-HD100E and GY-HD101E. The text mainly deals with the GY-HD100U and GY-HD101E.

Explanations concerning unique GY-HD100U and GY-HD101E functions are set off by the (GY-HD100U/GY-HD101E only) notice.

Information applicable only to the GY-HD100U is marked by "(U model only)".

Information applicable only to the GY-HD100E and the GY-HD101E is marked by "(E model only)".

(HDV/DV signal input is possible with the GY-HD100U/GY-HD101E.)

HDV / Mini DV
This unit is a HDV/DV video system format camera recorder. Videocassettes marked with the **HDV** symbol can be used.

The following phenomena may occur when tapes recorded on other units (including another GY-HD100) are recorded or played back on this camcorder.

- The transient section between scenes recorded on other units and those recorded on this unit may appear disturbed.
- Digital noise may appear during playback due to tracking errors.

- This unit records and plays back in the SP mode. Recording or playback in the LP mode is not possible. (In DV format)
- Due to manufacturing dispersion of tapes, we recommend not to record pictures within the first 2 to 3 minutes from the beginning of the tape.
- Before recording important scenes, be sure to perform a test recording and confirm that both video and audio are recorded correctly.
- Recorded video and audio contents are for private use. Other use may infringe on the rights of copyright holders.
- JVC cannot assume liabilities that may derive from the impossibility of normal recording or playback of video or audio due to malfunction of the camcorder or the video-cassette.

ACCESSORIES

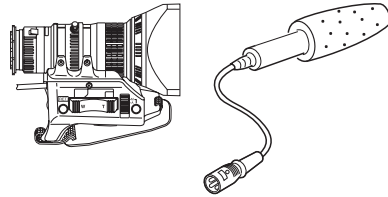

Lens

Microphone



Battery pack

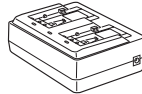

AC Adapter

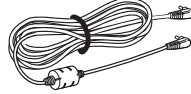

DC Cable



Power Cord
For GY-HD100U

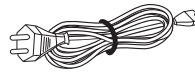

Power Cord
For GY-HD100E/GY-HD101E



Core Filters
For DC Cable (Gray)/Viewfinder Cable (Black)

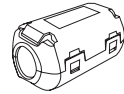

Clamp Filters
For Audio/IEEE1394 Cable

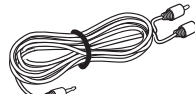

Audio Cable

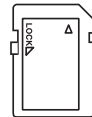

SD memory card

MAIN FEATURES

- This camcorder records in HDV format or DV format. DV format can record and play back SD (Standard Definition) video on Mini DV videocassettes. HDV format can record and play back HD (High Definition) or SD (Standard Definition) video on Mini DV videocassettes. There are two types of recording formats within HDV format. HDV 720p (720 effective scan lines, progressive scan) HDV 1080i (1080 effective scan lines, interlaced scan) This camcorder supports HDV 720p format. (HDV 720p, 480p, 576p) HDV and **HDV** are trademarks of Sony Corporation and Victor Company of Japan, Limited.
- 24p mode shooting function In HDV format, it records in 24p mode. It uses a 2:3:2:3 pulldown when recording to tape and converts the images to 60 frames. Component output is converted to 60 frames during playback as well. 24p DV format video uses a 2:3:2:3 pulldown (24p Mode). A 2:3:3:2 pulldown (24p Advanced Mode) is also supported. It can shoot with the same number of frames as movie film.
- Tapes recorded in the DVCAM format can only be played back (simple playback). Recording in the DVCAM format is not possible. DVCAM is a registered trademark of Sony Corporation.
- Supports 60 Hz/50 Hz HD or HDTV signals Supports both 60 Hz/50 Hz HD or HDTV signals. You can select this in a menu screen.
- Cross-convert video output During playback, you can output converted video from the video output connectors. You can select this in a menu screen.
- Focus assist function Enables easy and accurate focusing during shooting.
- Motion smoothing function During progressive shooting (HDV 30p, 25p, 24p), you can record smoother video than with normal progressive video.
- User buttons added Enables you to switch camera settings instantly to suit the shooting conditions.
- Time code reader/generator The built-in time code reader/generator can be used to record the time code and user's bits.
- Built-in large 3.5" color LCD display In addition to displaying the camera image and the playback image, the LCD monitor shows the status screens, menu screens for settings, and alarm indications.
- Built-in monitor speaker for audio checking The input audio can be monitored in recording or EE mode. The playback sound can be monitored in the playback mode. The speaker also outputs an alarm tone in case an abnormal condition occurs in the unit.
- Recording check function for convenient recording review function
- Camera section designed with 3-CCD system for high-quality picture 1/3" 3-CCD with 1,110,000 effective pixels employed. Digital signal processing for reproduction of HDV/DV high-quality picture.
- Multi-Zone Auto Iris Detection Circuit Multi-zone auto iris detection circuit ensures optimum iris position even in back light conditions or when a bright subject moves in a frame.
- Safety Zone indication in viewfinder
- Zebra pattern video level indication in viewfinder
- Full Auto Shooting (FAS) function Eliminating the need for troublesome switch or filter operations, the FAS function automatically provides a wide range of compatibility with shooting conditions which varies as you move between indoors and outdoors or between bright and dark locations.
- ND filters for 1/4ND, 1/16ND provided
- IEEE1394 connector IEEE1394 connector (6-pin) provided. Enables transfer of digital data to other equipment provided with IEEE1394 connector, such as a non-linear editing system. (Power cannot be supplied.)
- 1/3" bayonet type lens
- Camera output, VTR playback output (composite/component) possible
- Built-in color bars (ARIB (multi-format color bars), SMPTE/EBU type)
- Shutter speeds and menus can be selected using a dial, making it very easy to use.
- Variable scan shutter There is no flicker when shooting computer screens and other non-NTSC/PAL format screens.
- Slow shutter Makes it possible to brightly shoot video of dark subjects with little motion by accumulating the images.
- Backup recording function Continuous extended recording is possible by connecting to HDV/DV devices.

CONTENTS

ACCESSORIES	2
MAIN FEATURES	3
INTRODUCTION	
Precautions for Proper Use	6
Routine and Periodical Maintenance	7
Precautions for Use of Head Cleaning Tape	7
Battery Pack to be Used	8
Videocassette to be Used	8
Condensation	9
Characteristic CCD Phenomena	9
CONTROLS, INDICATORS AND CONNECTORS	
ZOOM Lens (Optional)	10
Front Section	11
Rear Section	12
LCD Door	13
Right Side Section	14
Left Side Section	16
Top Section	17
Indications on the LCD Monitor and in the Viewfinder	19
PREPARATIONS	
Basic System	28
Attaching the Zoom Lens (Provided)	29
Attaching the Microphone (Provided)	29
How to Attach the Viewfinder	29
Inserting an SD Memory Card	30
• Inserting an SD Memory Card	
• Taking out the SD memory card	
• About SD Memory Cards	
About the Viewfinder Cable	30
AC Operation	31
• Charging the Built-in Battery	
Battery Operation	32
• Charging the Battery Pack	
• Attaching the Battery Pack on the GY-HD100	
• Detaching the Battery Pack from the GY-HD100	
• Remaining Battery Power Display	
• Battery Recharge Times	
• Operating Time with Battery Pack	
• Precautions for the Battery Pack	
• Recharging	
PREPARATIONS FOR OPERATION	
Turning the Power ON	34
• Turning the Power ON	
• Turning the Power OFF	
Loading/Unloading the Cassette	35
Setting and Displaying the Date and Time	36
• Setting the Date and Time Style	
• Setting the Date and Time	
• Displaying the Time and Date on the Screen	
Displaying Time Code	38
Recording Time Codes in Continuation of Time Codes Recorded on Tape	39
Presetting and Recording of Time Code	39
• Presetting time cord data	
• Presetting user's bit data	
Screen Adjustment	41
Viewfinder Adjustment	41
Back Focus Adjustment	42
White Balance Adjustment	43
• White Balance Adjustment	
• Full Auto White Balance (FAW)	
SETTING AND ADJUSTMENTS BEFORE SHOOTING	
Setting the Video Format	44
Camera Settings	45
Screen Size (4:3/16:9) Mode Selection	45
Audio Input Signal Selection	46
• Selecting the CH-2 channel input connector	
• Selecting the audio signal input	
• Adjusting Audio during Recording	
• Monitoring Audio during Recording	

CONTENTS

SHOOTING OPERATION	
Basic Recording Operation	48
• If the Record-Standby Mode Continues	
• Checking Recorded Contents in Record-Standby Mode (Recording Check Function)	
HEADER REC Function	50
PLAYBACK MODE	
Playback Procedure	52
Fast-Forward, Rewind	52
Search	52
Outputting Audio	53
USING EXTERNAL COMPONENTS	
Connecting the Video Signal Cables	54
• Connecting the IEEE1394 Cable	
• Composite and Component Connections	
Dubbing with AV Devices	55
HDD/DV Dubbing	56
Backup Recording	58
MENU SCREENS	
Menu Screen Configuration	59
Setting Menu Screens	60
TOP MENU Screen	61
VIDEO FORMAT Menu Screen	62
CAMERA OPERATION Menu Screen	64
CAMERA PROCESS [1/2] Menu Screen	65
CAMERA PROCESS [2/2] Menu Screen	66
ADVANCED PROCESS Menu Screen	67
COLOR MATRIX ADJUST Menu Screen	68
SKIN COLOR ADJUST Menu Screen	68
SWITCH MODE Menu Screen	69
AUDIO/MIC Menu Screen	70
LCD/VF [1/3] Menu Screen	71
LCD/VF [2/3] Menu Screen	72
LCD/VF [3/3] Menu Screen	73
TC/UB/CLOCK Menu Screen	74
HEADER REC Menu Screen	75
TIME/DATE Menu Screen	76
OTHERS [1/2] Menu Screen	77
OTHERS [2/2] Menu Screen	78
FILE MANAGE Menu Screen	79
• Loading a menu settings file	
• Saving settings	
• Resetting the menu settings to the factory settings	
• Initializing (formatting) an SD memory card	
FEATURES OF THE CAMERA SECTION	
How to Use Skin Detail	82
Outputting color bars	84
OTHERS	
Warnings and Responses	85
Troubleshooting	88
How to Display the Hour Meter	89
Information for Users on Disposal of Old Equipment	89
Specifications	90
• EXTERNAL DIMENSIONS	

INTRODUCTION

Precautions for Proper Use

- Supply voltage
Make sure that the power is between 6.5 V and 7.9 V DC. If the power voltage is too low, abnormal color and increased noise may occur. Do not exceed 7.9 V DC in any case, or the unit could be damaged.
- Allowable ambient temperature and humidity
Be sure to use the unit within the allowable temperature range of 0°C to 40°C and a relative humidity of 30% to 80%. Using the unit at a temperature or humidity outside the allowable ranges could result not only in malfunction but the impact on the CCD elements could be serious as small white spots may be generated.
- Strong electromagnetic waves or magnetism
Noise may appear in the picture or audio and/or the colors may be incorrect if the camera is used near a radio or television transmitting antenna, in places where strong magnetic fields are generated by transformers, motors, etc., or near devices emitting radio waves, such as transceivers or cellular phones.
- Use of wireless microphone near the camera
When a wireless microphone or wireless microphone tuner is used near the camera during recording, the tuner could pick up noise.
- Avoid using or placing the unit in places;
 - subject to extreme heat or cold;
 - with excessive dirt or dust;
 - with high humidity or moisture;
 - subject to smoke or vapour such as near a cooking stove;
 - subject to strong vibrations or on an unstable surface;
 - also do not leave the unit for long hours in a parked car under direct sunlight or near room heating equipment.
- Do not leave the unit where it is subject to radiation or xrays or where corrosive gasses occur.
- Protect the unit from being splashed with water (especially when shooting in the rain).
- Protect the unit from being wet when shooting on a beach. In addition, salt and sand may adhere to the camera body. Be sure to clean the camera after use.
- Protect the unit against penetration of dust when using it in a place subject to sandy dust.
- Optical performance of lens
Due to the optical performance of the lens, color divergence phenomena (magnification chromatic aberration) may occur at the periphery of the image. This is not a camera malfunction.
- Noise may appear in the viewfinder when switching between the playback picture and the EE picture.
- Use the unit in an upright position.
If placed on its side, heat release efficiency will deteriorate, adversely affecting the tape transport. Depending on circumstances the tape may also be damaged.
- Vibrations
Colors may fail to appear and/or the image and sound may be disturbed during VTR playback in locations subjected to strong vibrations.
- Precautions for transportation
Do not drop or hit the unit against a hard object.
- Remove the videocassette before transporting the unit.
- Do not insert an object other than a videocassette in the cassette insertion slot. Be sure to close the cassette cover when the unit is not to be used for a long period.

- Do not set the POWER switch to OFF or remove the power cable during recording or playback. Otherwise the tape may be damaged.
- The sensitivity level of the provided microphone is set lower than the reference input (-60 dBs) setting.
- When the unit is not in use, be sure to set the POWER switch to OFF in order to reduce power consumption.
- Cleaning the body: Wipe body with a dry, soft cloth. To prevent deformation of the body, etc. and to avoid operation hazards, do not allow volatile liquids such as benzine and thinner to touch the body, and do not wipe it with a cloth soaked in such a liquid. When it is extremely dirty, soak the cloth in a solution of neutral detergent, wipe the body with it, and then use a clean cloth to remove the detergent.
- The camera may not show stable pictures in the period immediately after the power is turned on, but this is not a malfunction.
- A sound occurs when the built-in head cleaner that runs when you load or eject a videocassette operates, but this is not a malfunction.
- The LCD monitor and the viewfinder screen
The LCD monitor and the viewfinder screen are manufactured using high-precision technology. Black spots may appear on the LCD monitor and the viewfinder screen, or red, blue, green and/or white spots may not turn off. However, this is not a malfunction and these spots are not recorded on the tape.
- If you use the camcorder continuously for a long period of time, the characters displayed in the viewfinder may temporarily remain on the screen. This is not recorded on the tape. In addition, they are no longer displayed if you turn the power off and then on again.
- If you use the camcorder in a cold location, the images may appear to lag on the screen, but this is not a malfunction. This is not recorded on the tape.
- Do not insert fingers or foreign objects into the cassette insertion slot as this may result in personal injury or damage to the mechanism.
- Use the provided AC adapter for the power supply.
- Use the specified power cord (accessory).
Using a power cord other than the one specified or using a damaged cord will result in a fire or electric shock.
- Do not use the provided power cord with a device other than this one.
- To prevent damage to the connectors, use the camcorder with the connector covers on when you are not using the video signal output connectors.

CAUTION

- Do not point the lens or viewfinder directly at the sun or other strong light source.
 - Eye damage could result.
 - If the lens or viewfinder is left pointed at the sun, rays may collect inside the unit and cause damage or a fire.
- When carrying the camera, be sure to hold the carrying handle. Holding the lens or viewfinder may result in damage.

Routine and Periodical Maintenance

The GY-HD100 incorporates precision mechanical parts, which will collect dirt, wear out and deteriorate as the unit is used. After the unit has been used for a long period even in a normal environment, the heads, drums and tape transport mechanisms also collect dirt. Especially, dust which penetrates the inside of the VTR section during outdoor use will promote the wear and deterioration of mechanical parts by causing poor contact between tape and heads or failing to maintain the video and audio quality at high levels. To prevent wear and deterioration, clean the mechanical parts using a head cleaning tape as routine maintenance. However, cleaning with a head cleaning tape alone is not enough for cleaning the entire tape transport mechanism, so it is also recommended to apply periodical maintenance (inspection) to prevent the sudden occurrence of failure. As the replacement, adjustment and servicing of parts require advanced skill and equipment, please consult the person in charge of professional video equipment at your nearest JVC-authorized service agent.

Head Cleaning

- To maintain beautiful pictures and sound, be sure to use a head cleaning tape to clean the head periodically. (See "Precautions for Use of Head Cleaning Tape".) If headcleaning is not performed periodically, a type of mosaic noise called block noise may appear in the picture or sound may be interrupted.



Block Noise

- Please use cleaning tape produced by JVC. Do not use head cleaning tapes other than specified.
See "Precautions for Use of Head Cleaning Tape" about how to use the head cleaning tape and precautions for use of the head cleaning tape.
- When dust adheres to the heads, the warning message "HEAD CLEANING REQUIRED!" is displayed on the LC monitor and in the viewfinder during playback, edit search, and recording check using the RET button on the lens section.

Periodical Maintenance

Contents : Check or replace the following mechanical parts according to the running time.

Usage Time	500H	1000H	1500H	2000H
Drum assembly (including heads)	○	☆	☆	●
Tape guides, rollers	○	☆	☆	●
Belt gears	—	☆	☆	●
Drive parts	—	—	☆	●

- : Clean, check and adjust.
- ☆: Clean and check. Replace as required.
- : Replace.

INTRODUCTION

- The maintenance contents vary depending on the operating environment and method. Therefore, the above data should be considered as a reference.

Time management

The accumulated running time of the unit can be confirmed with the hour meter display (which shows the accumulated drum and fan motor running time). See "How to Display the Hour Meter" on page 89.

For consultations related to the maintenance planning or cost, please contact the person in charge of professional video equipment at your nearest JVC-authorized service agent.

Precautions for Use of Head Cleaning Tape

Please use cleaning tape produced by JVC.

Adhere to the following precautions when using the head cleaning tape.

1. Insert the cleaning tape.

Press the PLAY/STILL button after the cleaning tape is fully loaded.

The tape runs for 10 seconds at a time in the PLAY mode. (The tape stops automatically and then the unit enters the STOP mode.)

2. Do not use the tape more than four times at the most for each cleaning.

- Use the following chart as a guide for periodical head cleaning.

Running	Low temperature	Room temperature	High temperature
Operating environment	0°C to 10°C	10°C to 35°C	35°C to 40°C
Yardstick for use of cleaning tape	1 to 2 times every 5 hours	1 to 2 times every 20 to 30 hours	1 to 2 times every 5 hours

- Note 1) When used in a low humidity environment, head cleaning should be conducted at intervals half of those given in the below chart.
- Note 2) If an M-DV80 tape is used immediately after head cleaning, the "HEAD CLEANING REQUIRED!" indicator may remain on. In this case, let the tape run as the indicator will turn off after the tape has run for a while.
- Note 3) Use the cleaning tape in the room temperature (10°C to 35°C).
- Note 4) The cleaning tape case contains instructions for use of the cleaning tape. However, some of these instructions differ from the contents of this sheet. When using the cleaning tape, please follow the instructions of this sheet.
- Note 5) If the "HEAD CLEANING REQUIRED!" does not disappear after repeated head cleanings, the recording tape may be abnormal. Avoid excessive repeated use of the head cleaning tape.

INTRODUCTION

Battery Pack to be Used

The GY-HD100 can use any of the following batteries.

- BN-V428, BN-V438

Videocassette to be Used

- Use JVC's videocassette tapes marked with the **Hi-Fi** symbol.
- Mini DV videocassette : M-DV63HD
M-DV63PROHD

- * Do not use M-DV80.
- Videocassettes cannot be used upside down.
- Avoid storing a videocassette with its tape not being completely wound, as this may damage the tape. Rewind it to the beginning before placing a cassette into storage.
- Store videocassettes in a place with little humidity and good ventilation where mould does not form.
- After a videocassette tape has been used repeatedly, it becomes unable to maintain full performance due to an increase in noise caused by dropouts, etc. Do not continue to use a dirty or damaged tape, as this will reduce the rotary head life.
- Videocassette tapes with the **Hi-Fi** symbol are provided with a switch on the back to prevent accidental erasure.
- Slide the switch to SAVE to protect the required recording in the tape from being overwritten.
- To record on the tape, slide the switch to REC.

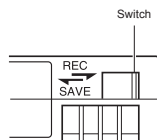

For recording and storing videotapes in the best condition

Observe the following instructions for the best recording and storage of videotapes.

- Take care of the conditions of handling videotapes. It is recommended that you record and store videotapes in the environment below.

	Recording	Storage	
		Short period (Up to 10 years)	Long period (Over 10 years)
Temperature	17°C to 25°C	15°C to 23°C	15°C to 19°C
Humidity	30% to 70%	40% to 55%	25% to 35%
Hourly temperature change	Less than 10°C	—	—
Hourly humidity change	Less than 10%	—	—

- Do not leave the videotapes neglected for a long period. If videotapes are left wound for a long period of time, it may result in distortion of the tape. Also it may cause tape-to-tape adhesion (known as blocking). It is recommended that videotapes be unspooled and rewound once a year for refreshing.
- When tapes are not in use, store them in cases and on end. Storage cases protect videotapes from humidity, dust and ultraviolet light. Keep tapes in cases and do not store them lying flat. When housed in a horizontal position, pressure from other tapes can cause distortions and deformations of the tape edges.

Condensation

- If the unit has been cooled down in a cold place and is then carried to a warm place, the moisture contained in the warm air may adhere to the head drum or tape guides and be cooled into water droplets. This phenomenon is referred to as condensation (dewing). When this occurs, the head drum and tape guides are covered with droplets allowing the tape to be stuck to them, leading to tape damage.

- Condensation occurs in the following cases:

- When the unit is suddenly moved from a cold place to a warm place.
- When a room heater has just started or when the unit is exposed directly to cold air from an air conditioner.
- When the unit is placed in a very humid place.

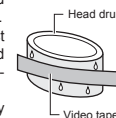

Do not leave the videocassette inserted when moving the camera under conditions where the temperature environment changes.
After moving the unit, do not use until the internal parts have stabilized.

- "CONDENSATION ON DRUM" is displayed on the LCD monitor and in the viewfinder when condensation occurs in this unit.



Keep the power on until the warning message disappears.

- Pay attention to condensation even before the condensation indication appears.

As condensation forms gradually, the condensation indication may not appear for the first 10-15 minutes after condensation has formed inside.

In an extremely cold place, the condensation could freeze and turn into frost. In such a case, it takes an additional 2-3 hours for the frost to first melt into condensation and then to be dissolved.

- To prevent condensation

When moving the unit from one place to another where the temperatures are greatly different, first remove the videocassette, place the unit in a tightly sealed vinyl bag, and then move it to a new environment.

To ensure no condensation occurs, allow the temperature of the unit in the bag to reach that of the new environment before using it.

INTRODUCTION

Characteristic CCD Phenomena

Smear and Blooming

Due to the physical structure of a CCD it is possible to induce vertical streaking (called "smear") when shooting an extremely bright light source. Another effect is the expansion of light around a bright light or object (called "blooming").

The CCD employed in this unit is characterized by inducing very little smear or blooming. Nevertheless, please take note that smear or blooming may be induced when shooting a bright light source.

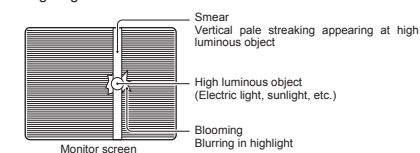

Moire or Aliasing

Shooting stripes or fine patterns may cause a jagged effect or a banding in fine mesh patterns.

White dots

High temperatures can cause CCD sensor pixels to produce the effect of white dots in the image. This condition is conspicuous especially when gain is applied.

This is a characteristic of the charged-coupled device (CCD). As far as possible, use the unit under conditions where the temperature of the unit does not increase.

CONTROLS, INDICATORS AND CONNECTORS

ZOOM Lens (Optional)

Th16 x 5.5BRMU

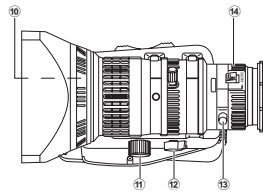
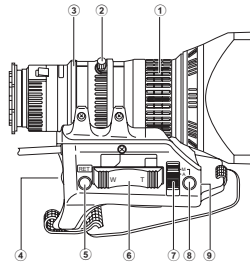

- ① **FOCUS ring**
Manual focus ring.
- ② **ZOOM lever/ring**
This is the manual zoom ring equipped with a zoom lever. To adjust the zoom manually, turn the zoom mode knob ⑫ to position "M".
- ③ **IRIS ring**
Manual iris ring. To activate the auto iris feature, set the Iris Mode switch ⑦ to "A".
- ④ **[VTR] VTR trigger button**
To start/stop shooting.
- ⑤ **[RET] Return video button**
You can only monitor the return video signal from the VTR from the viewfinder, LCD monitor and video signal connector while this button is pressed.
When you set the LENS RET item to "FOCUS ASSIST" in the SWITCH MODE menu screen, you can use this button as the FOCUS ASSIST button.
☞ See page 69.
- ⑥ **ZOOM servo control lever**
To operate the servo zoom feature with this lever, set the ZOOM knob ⑫ to "S".
 - Pressing the "W" section of this lever increases the angle of the lens for a wider shooting angle.
 - Pressing the "T" section of this lever narrows the lens angle perspective for telephoto shots.
 - Pushing harder changes the speed of the zoom.

- ⑦ **IRIS mode switch**
A : Activates the auto iris feature.
M : Allows manual iris control.
- ⑧ **Momentary auto iris button**
When the IRIS mode switch ⑦ is at "M", pushing this button activates the Auto Iris Function while it is held down only.
- ⑨ **[S] IRIS speed adjusting control**
For adjusting the iris operation speed.

MEMO

If the speed becomes too fast, hunting may occur. To avoid the phenomena described above, perform adjustment again.

- ⑩ **FILTER thread**
Protect the lens with a clear filter or UV filter by screwing the filter onto the thread inside the lens hood from the front. Other filters can be used for various effects.
- ⑪ **ZOOM servo connector**
Connect an optional zoom servo unit here.
- ⑫ **[ZOOM] ZOOM mode knob**
S : Servo zoom mode. Allows operation by the zoom servo control lever ⑥.
M : Manual zoom mode. Allows zoom control by the zoom lever/ring ②.

- ⑬ **BACK FOCUS ring/fixing screw**
For back focus adjustment only. Secure with the screw knob after adjustment. ☞ See "Back Focus Adjustment" on page 42.
- ⑭ **Macro focusing ring (for close-up shooting)**
By rotating this ring in the direction of the arrow, close-up shooting of very small objects becomes possible. Normal focus adjustment and zooming are not available in the macro mode.
To shoot images in the macro mode, set the focus ring ① to the infinite position (∞) and the zoom ring ② to the maximum wide-angle position. To adjust the focus of the macro image, rotate this ring in the direction of the arrow until the object is focused.

CAUTION

- The back-focus knob is located close to the macro ring, be careful not to mistake the back-focus knob for the macro ring.
- After the required operation, be sure to return the macro focusing ring to the normal position.
☞ See "Attaching the Zoom Lens (Provided)" on page 29.
☞ See "Back Focus Adjustment" on page 42.

CONTROLS, INDICATORS AND CONNECTORS

Front Section

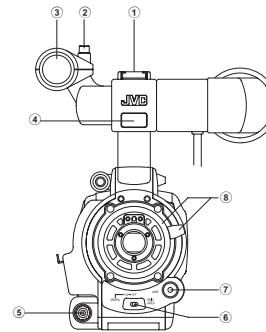

- ① **Shoe**
Makes it possible to mount separately sold lights and accessories.
- ② **Knob**
This is the mounting knob for the microphone holder ③.
- ③ **Microphone holder**
Makes it possible to attach the provided microphone or a separately sold microphone.
☞ See "Attaching the Microphone (Provided)" on page 29.
- ④ **Front tally lamp**
This lamp lights up when the GY-HD100 enters the record mode. It blinks during the transition to the record mode. When the tape has run out, or the VTR enters the warning mode, it blinks quickly.
 - Use the FRONT TALLY item on the OTHERS [1/2] menu screen to select whether or not the lamp should light and the lighting pattern.
☞ See page 77.
- ⑤ **[LENS] Lens control connector**
Connect 12-pin lens control cable from lens here.

Pin No.	Function	Pin No.	Function
1	Return switch	7	Iris position
2	VTR trigger	8	IRIS A/R INPUT
3	GND	9	EXTENDER position
4	Lens AUTO/MANU control	10	ZOOM position
5	IRIS control	11	-
6	+12V DC	12	-

- ⑥ **[ZEBRA] Zebra switch**
When this switch is ON, a zebra pattern is imposed on the viewfinder or LCD areas having luminance levels in accordance with the menu settings made for the video signal. This pattern can be used as a reference for manual adjustment of the lens iris. Zebra patterns are also displayed during color bar display when this switch is set to ON.
 - The default value is 70% - 80%. The luminance level can be changed with the ZEBRA setting in the LCD/VF [1/3] menu screen.
☞ See page 71.
- While this switch is pressed to the SKIN AREA side, the color tone areas specified with the SKIN COLOR ADJUST item on the ADVANCED PROCESS menu are indicated in the viewfinder. The switch returns to the OFF position when released.
☞ See "How to Use Skin Detail" on page 82.
- * The Skin Detail color tone areas are not indicated while the color bar or VTR playback picture is shown in the viewfinder or on the LCD monitor.
- ⑦ **[AWB] Auto white balance button**
When the WHT.BAL switch ⑬ on page 15 is set to A or B and you press this button, the white balance is automatically adjusted.
 - * It is not activated in preset, full auto shooting, full auto white balance and color bar modes.
☞ See "White Balance Adjustment" on page 43.
- ⑧ **Lens mounting ring/Lens lock lever**
Hold the lens and use the lever to turn the ring anticlockwise to release lens.
To mount lens make sure the lens guide pin fits well, and then turn the ring clockwise until firm.
☞ See "Attaching the Zoom Lens (Provided)" on page 29.

CONTROLS, INDICATORS AND CONNECTORS

Rear Section

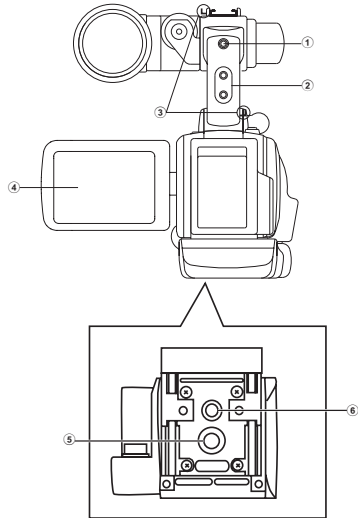

① Back tally lamp

This lamp lights up when the GY-HD100 enters the record mode. It blinks during the transition to the record mode. When the tape has run out, or the VTR enters the warning mode, it blinks quickly.

- Use the BACK TALLY item on the OTHERS [1/2] menu screen to select whether or not the lamp should light and the lighting pattern.

☞ See page 77.

② [PHONES] Earphone jack

This is a stereo mini-jack for connecting an earphone for audio monitoring. Plug in an earphone or headphone with a 3.5 mm diameter plug. The earphone can also be used to monitor alarm tones in accordance with the circumstances. The audio channel to be output is selected with the AUDIO MONITOR item on the AUDIO/MIC menu screen and MONITOR SELECT switch ⑮ on page 18. The audio output level is adjusted with the Audio monitor volume control ③ on page 14.

MEMO

- The volume of the alarm sound is set with the ALARM VR LEVEL item on the OTHERS [1/2] menu screen.
- When using a stereotype jack and stereo sound should be output, the following setting should be performed. Set the MONITOR SELECT switch ⑮ on page 18 to BOTH. Set the AUDIO MONITOR item on the AUDIO/MIC menu screen to STEREO.

③ Shoulder belt hooks

Allows you to attach a separately sold shoulder belt.

④ LCD monitor

Shows a color camera image or the VTR playback picture. It is also used for displaying the following:

- Menu Setting screens
- Characters showing the whether the GY-HD100 is set to shooting mode or VTR playback mode
- Date and time and time code
- Audio level meter
- Warning indications, etc.

☞ See page 19.

⑤ Tripod mount

Use this hole when mounting the camera onto a tripod. (Use a screw shorter than 8 mm.) Always make sure that the camera is securely mounted.

⑥ Rotation-preventive hole

Use this to prevent the camera from falling off the tripod. Always make sure that the camera is securely mounted.

CONTROLS, INDICATORS AND CONNECTORS

LCD Door

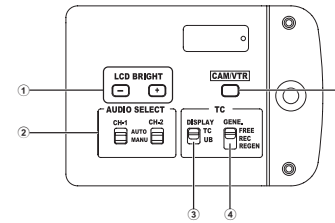

① [LCD BRIGHT +/-] LCD brightness +/- button

This button is for adjusting the brightness of the LCD monitor display.

- Pushing the button in the + direction makes the monitor brighter.
- Pushing the button in the – direction makes the monitor darker.
- Pushing the +/- buttons simultaneously returns the setting to the standard setting.

② [CH-1/CH-2 AUDIO SELECT] CH-1/CH-2 audio selector switch

Selects the method of adjusting the CH-1 and CH-2 audio channel audio levels.

AUTO : A limiter works to suppress the audio level when excessive audio is input. When the input level is low, the audio level does not increase. The "AUTO" LED in the CH-1/CH-2 AUDIO LEVEL area ⑰ on page 15 lights.

MANUAL : Allows you to adjust the audio levels using the CH-1/CH-2 AUDIO LEVEL volume controls ⑰ on page 15. When "ON" is set for the FULL AUTO switch ⑱ on page 18, this becomes "AUTO" mode.

③ [TC DISPLAY] TC/UB display switch

Selects the contents displayed on the TC counter of the LCD monitor or in the viewfinder. (This switch works when the TC/UB item on the LCD/VF [2/3] menu screen is set to ON.)

TC : Set to this position to display time code values.
UB : Set to this position to display the user's bits values.

④ [TC GENE.] Time code generator setting switch

Switch for setting the time code generator to preset mode or regeneration mode. It is also used to select the time code run mode when the preset mode is selected.

FREE : The preset mode is selected, and the time code run mode becomes the FREE run mode. Set to this position to record with the time code or user's bits set anew (preset). In this setting, the time code always operates in the run mode.

* If this setting is used when recording scenes one after another, the time codes become discontinuous at the transition points between scenes.

REC : The preset mode is selected, and the time code run mode becomes the REC run mode.

Set to this position to record with the time code or user's bits set anew (preset). The time code operates in the run mode during recording only. If this setting is used when recording scenes one after another, the time codes are recorded as continuous time codes.

REGEN : Regeneration mode, in which the unit reads existing time codes on the tape and records time codes in continuation of the existing ones. Set to this position when you want to add additional time codes to time codes already recorded on the tape.

MEMO

Preset of time code and user's bits is performed on the TC/UB/CLOCK menu.

☞ See page 39.

☞ See "TC/UB/CLOCK Menu Screen" on page 74.

⑤ [CAM/VTR] Camera/VTR mode switch button

Each time you press this button, the mode switches between camera mode and VTR mode.

When you do this, the VTR indicator ⑰ on page 18 displays the following statuses.

While the mode is being switched: Flashing

In VTR mode : Lit

In camera mode : Off

- Select the Camera mode to record the camera image.
- Select the VTR mode to playback VTR or to input the HDV/DV signal from the IEEE1394 connector ④ on page 16. (HDV/DV signal input is possible with the GY-HD100U/GY-HD101E.)
- When the power is turned on, the mode becomes the Camera mode.

Right Side Section

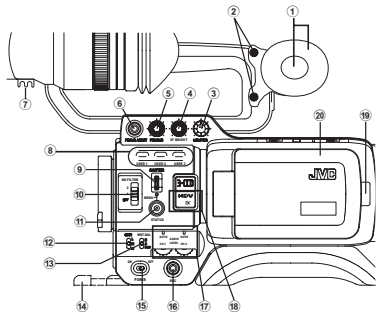

- ① **Monitoring speaker (Ear pad)**
 - In the Camera mode, the input sound can be EE monitored.
 - In the VTR mode, the speaker outputs the VTR playback sound.
 - The sound to be output is selected with the MONITOR SELECT switch ⑮ on page 18.
 - The sound level is adjusted with the MONITOR sound level volume ③. This speaker also outputs various warning sounds superimposed on other sound.
 - ☞ See "Alarm Sound" on page 87.
- ② **Ear pad set screw**
 - Screw for adjusting the height of the ear pad.
- ③ **[MONITOR] Audio monitor volume control**
 - Adjusts the volume of the monitoring loudspeaker and earphone.
- ④ **[VF BRIGHT] Viewfinder brightness adjustment**
 - To adjust the brightness of the viewfinder.
 - ☞ See page 41.
- ⑤ **[PEAKING] Contour adjustment**
 - To adjust the contours of the LCD monitor and viewfinder image.
 - * When the Focus Assist function is running, this control does not operate.
 - ☞ See page 41.
- ⑥ **[FOCUS ASSIST] Focus assist button**
 - When you press this button during shooting, the area of focus is displayed in blue, red or green, making it easy to focus accurately.
 - ☞ See "LCD/VF [1/3] Menu Screen" on page 71.
- ⑦ **Clamp**
 - Attach the cable from the viewfinder here.

- ⑧ **[USER1/2/3] User buttons**
 - You can assign camera functions to the USER1 - 3 buttons.
 - Use them to switch shooting conditions depending upon the subject.
 - Set them using the USER1 - 3 items in the SWITCH MODE menu screen.
 - ☞ See page 69.

MEMO

- The USER buttons work together with the menu settings.
- When a menu screen is being displayed, they also function as menu operation buttons. ☞ See "Setting Menu Screens" on page 60.
- ⑨ **[SHUTTER] Shutter/Menu dial**
 - Every time this dial is pressed while in the normal screen mode (when the menu screen is not displayed), the shutter speed switches between on/off.
 - When this dial is turned 1 click up or down in the normal screen mode, the shutter speed indicator is shown for about 3 seconds on the LCD monitor or in the viewfinder. The shutter speed is changed when this dial is turned while the shutter speed indicator is shown.
 - ☞ See page 69.
 - When this dial turned upward or downward while the menu screen is displayed, the cursor (▶) also moves upward or downward to allow selection of items in the menu. To change the setting value of the item, press this dial. When the setting value starts blinking, turn this dial upward or downward to change the setting.
 - ☞ See "Setting Menu Screens" on page 60.

- ⑩ **[ND FILTER] ND filter switch**
 - Switches the built-in ND filter.
 - OFF : Turns the filter OFF (FILTER OFF)
 - 1 : Cuts the light intensity to approximately 1/4. (1/4ND)
 - 2 : Cuts the light intensity to approximately 1/16. (1/16ND)
 - When you change this switch, the type of the new ND filter is displayed in the LCD monitor or viewfinder.

CAUTION

If you switch the ND filter while shooting is in progress, the picture may be disturbed or noise may occur in the audio.
☞ See "Camera Settings" on page 45.

- ⑪ **[STATUS] Status/Menu button**
 - Pressing this button in the normal screen mode (condition in which the menu screen is not shown) displays a status screen in the viewfinder or on the LCD monitor. The displayed status screen changes each time the button is pressed.
 - ☞ See "Status Screens" on page 19.
 - Pressing this button for more than 1 second in the normal screen mode displays the menu screen in the viewfinder or on the LCD monitor. Pressing this button while the menu screen is displayed in the viewfinder or on the LCD monitor makes the menu screen disappear.
 - ☞ See "Setting Menu Screens" on page 60.

- ⑫ **[GAIN] Sensitivity selector switch**
 - Electronically boosts the light sensitivity when there is insufficient illumination on the subject.
 - The boosting level differs depending on the switch position as follows:
 - (Factory presets)
 - L : 0 dB (no boosting is applied)
 - M : 9 dB (boosted to approximately 3 times the original)
 - H : 18 dB (boosted to approximately 8 times the original)
 - The boosting level for each switch position can be changed with the SWITCH MODE menu screen.
 - ☞ See page 69.
 - The more the boosting level is increased, the more the resulting image will be noisy.
 - When the FULL AUTO switch ⑯ on page 18 is "ON", this is fixed at "ALC".

- ⑬ **[WHT.BAL] White balance switch**
 - Three white balance modes are selectable with this switch.
 - B : Switch into white balance mode memorized in B. If white balance is performed with the switch in this position, it will be memorized into B.
 - A : Switch into white balance mode memorized in A. If white balance is performed with the switch in this position, it will be memorized into A.
 - PRST : Switch into white balance mode (3200K or (PRESET) 5600K) set in PRESET TEMP. item on the CAMERA OPERATION menu screen.
 - ☞ See page 64.

FAW (Full Auto White Balance) mode can be set to A, B or PRESET with the SWITCH MODE menu screen.
☞ See page 69.

In the FAW mode, video color temperatures are constantly sampled for automatic adjustment to a proper white balance.

- When the FULL AUTO switch ⑯ on page 18 is "ON", this is fixed at "FAW".

- ⑭ **Stand**
 - When attaching the lens, slide the stand forward.

CAUTION

There is a risk that the camcorder will fall onto the viewfinder side when the lens is not attached, so leave the lens attached even if you are not using it.

- ⑮ **[POWER] Power ON/OFF switch**
 - Switch that turns the power ON/OFF.
 - When the power is OFF, "POFF" is displayed in the LCD monitor or viewfinder.
 - * Wait at least 5 seconds if you need to turn the power on again.

- ⑯ **[REC] REC trigger button (start/stop recording)**
 - Start and stop recording using this button.
 - (This works together with the REC trigger button on the top and the lens VTR trigger button.)
 - When "SPLIT" is set for the 1394 REC TRIGGER item on the OTHERS [2/2] menu screen, this button becomes the start/stop recording button for an external device.
 - ☞ See page 78.
 - ☞ See "Backup Recording" on page 58.

- ⑰ **[CH-1/CH-2 AUDIO LEVEL] CH-1/CH-2 Audio level controls and AUTO LED**
 - Allow you to adjust the audio level for the CH-1 and CH-2 audio channels.
 - To use these controls, set the CH-1/CH-2 AUDIO SELECT switch ② on page 13 to "MANUAL".
 - When the FULL AUTO switch ⑯ on page 18 or the CH-1/CH-2 AUDIO SELECT switch ② on page 13 is set to "AUTO", "AUTO LED" lights. (The audio level controls do not work.)

- ⑱ **[HDV/DV LED]**
 - In camera mode, this lights according to the setting for the video format being shot.
 - In VTR mode, it lights according to the video format being recorded on tape or the IEEE1394 input video format.
 - HDV : Lights when the format is HDV.
 - DV : Lights when the format is DV.

MEMO

- During a system error, HDV/DV flash alternately.
☞ See page 86.
- Select whether or not to have this light in the FORMAT LED item on the OTHERS [1/2] menu screen.
☞ See page 77.

- ⑲ **LCD door lock and release knob**
 - To open the LCD door, move this knob on the direction toward the rear section.

- ⑳ **LCD door**
 - LCD monitor door.
 - The LCD monitor is located on the inner side of the door. The LCD monitor can be viewed when this door is opened. The door can be turned to change the orientation of the LCD monitor, and it can be rotated so that it can be accommodated in the main body of the camera.
 - ☞ See page 41.

CONTROLS, INDICATORS AND CONNECTORS

Left Side Section

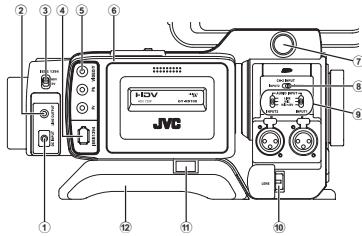

- ① **[DC INPUT] DC connector**
Power input for 7.2 V DC accepts the supplied AC adapter.
☞ See "AC Operation" on page 31.
- ② **[LINE OUTPUT] Line output connector (φ3.5mm)**
Output connector for audio signals.
• Outputs the input audio signal in the Camera mode.
• Outputs the playback audio signal in the VTR mode.
• When a HDV/DV signal (IEEE1394) is input, the EE sound of the input audio signal is output in the VTR mode. (GY-HD100U/GY-HD101E only)

MEMO

Alarm sound is not output.

- ③ **[IEEE1394] IEEE1394 switch**
Input/output signal and playback signal video from the IEEE1394 connector ④. Set this switch according to the format.
HDV : For HDV format
DV : DV format
- ④ **[IEEE1394] IEEE1394 connector (6-pin)**
Using an IEEE1394 cable (optional), a digital video component with IEEE1394 connector can be connected here.
☞ See "Connecting the IEEE1394 Cable" on page 54.
☞ See "HDV/DV Dubbing" on page 56.
- ⑤ **[VIDEO/Y, Pb, Pr] Video Signal Output Connectors (RCA)**
These are connectors for component or composite video signal output.
The signal switches automatically depending upon the cables connected to these connectors.
• You can select the output signal using the OUTPUT TERMINAL item on the VIDEO FORMAT menu.
You can also select whether or not to add a setup signal in the SET UP item. ☞ See page 63.
• When the OUTPUT CHAR. item on the OTHERS [1/2] menu screen is ON, the menu setting screen is also displayed in the video from the video signal output connector. ☞ See page 77.
☞ See "Dubbing with AV Devices" on page 55.

MEMO

Put the covers on the connectors when you are not using them.

- ⑥ **Cassette cover**
Sliding the EJECT switch ⑪ on page 17 located on the top section opens this cover to allow insertion or removal of the videocassette.

CAUTION

To prevent foreign objects from entering the internal parts of the VTR unit, do not leave the unit with the cover open for extended periods of time.

- ⑦ **Viewfinder connector (6-pin)**
Connect the cable from the viewfinder here.
- ⑧ **[CH-2 INPUT] CH-2 audio input connector selector switch**
Selects the CH-2 audio input connector.
INPUT1 : Inputs the audio from the INPUT1 connector ⑩ into CH-2.
INPUT2 : Inputs the audio from the INPUT2 connector ⑩ into CH-2.

MEMO

The audio from the INPUT1 connector is also input into CH-1 regardless of the setting.

- ⑨ **[AUDIO INPUT] Audio input signal selector switch**
This switch is used to select the input sound signal from INPUT1 or INPUT2 connector.
LINE : Set to this position when connected to audio equipment, etc. The reference input level is +4 dBs.
MIC : Set to this position when the dynamic microphone is connected.
MIC+48V : Set to this position when a microphone requiring +48 V power supply (phantom microphone, etc.) is connected.

CAUTION

When connecting a component that does not require +48 V power supply, make sure that the switch is not set to MIC+48V before the component is connected.

MEMO

You can select the normal input level for MIC and MIC+48V in the INPUT1, 2 MIC REF. item on the AUDIO/MIC menu screen.
☞ See page 70.

- ⑩ **[INPUT1/INPUT2] INPUT1/INPUT2 audio input connectors**
These are audio input connectors for connecting to an external audio device or microphone.
• Set the [AUDIO INPUT] switch ⑨ according to the device to be connected.
• Set the CH-2 audio input connector using the [CH-2 INPUT] switch ⑧.
The CH-2 audio from the set connector is recorded.
- ⑪ **Shoulder pad slide button**
Button to adjust the position of the shoulder pad.
When you press this button, you can move the position of the shoulder pad ⑫ forward or backward.

- ⑫ **Shoulder pad**

CONTROLS, INDICATORS AND CONNECTORS

Top Section

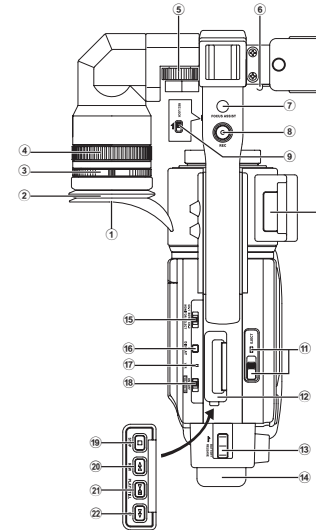

- ① **Viewfinder**
Displays the camera image and the playback picture.
- ② **Eyepiece**
Ensures that ambient light does not reach the viewfinder screen or falls into the eye of the cameraman.
- ③ **Eyepiece focus ring**
You can adjust the focus by turning this ring.
- ④ **Eyepiece mounting ring**
You can adjust the position of the eyepiece forward or backward by loosening this ring.
- ⑤ **Slide mounting ring**
You can adjust the position of the viewfinder left or right by loosening this ring.
- ⑥ **Clamp**
Attach the microphone cable here.
- ⑦ **[FOCUS ASSIST] Focus assist button**
When you press this button during shooting, the area of focus is displayed in blue, red or green, making it easy to focus accurately.
☞ See "LCD/VF [1/3] Menu Screen" on page 71.

- ⑧ **[REC] REC trigger button (start/stop recording)**
Start and stop recording using this button.
(This works together with the REC trigger button on the right panel and the lens VTR trigger button.)
- ⑨ **[REC LOCK] REC LOCK switch**
Slide this switch in the direction of the arrow to lock the [REC] trigger button ⑧. Use this to prevent unwanted recording.
(The REC trigger button on the right panel and the lens VTR trigger button are not locked.)
- ⑩ **SD memory card cover**
When you open this cover, you can insert and remove the SD memory card.
☞ See "Inserting an SD Memory Card" on page 30.
When an SD memory card is loaded
• You can save, call up and reset the menu settings on this camcorder.
• You can initialize (format) an SD memory card.
☞ See "FILE MANAGE Menu Screen" on page 79.
- ⑪ **[EJECT] Eject switch and LED**
Slide this switch to the side to insert or eject a videocassette tape.
The LED lights while ejecting is in progress.

MEMO

- It takes a few seconds before the videocassette is ejected. Do not close the cassette cover during the eject operation.
- Do not touch the cassette insertion slot or cassette during the eject operation. This could result in damage.

- ⑫ **Operation cover**

Open this cover when operating in the playback mode. Otherwise, keep this cover closed.
This cover can be opened by sliding it to the side.

MEMO

When the STOP button ⑬ is pressed in the Camera mode to set the VTR operation mode indicator to indicate STOP, playback operations become possible.

- ⑬ **[BATTERY RELEASE] Battery pack lock release lever**
Slide this lever forward to remove the battery pack.
- ⑭ **Battery pack**
Attach the provided battery pack (BN-V428).
☞ See "Battery Operation" on page 32.

Top Section (Cont'd)

- 15 [MONITOR SELECT] Audio monitor selector switch**
 This switch is used to select the monitor sound output and playback sound output from the monitoring speaker ① on page 14 or the PHONES jack ② on page 12.
- CH-1 : The CH-1 channel audio is output.
 BOTH : CH-1 and CH-2 channel audio are output mixed.
 When this setting is selected, the menu screen can be used to select whether the mixed sound or stereo sound should be output via the PHONES jack. (AUDIO MONITOR item on the AUDIO/MIC menu screen)
 When AUDIO MONITOR item on the AUDIO/MIC menu screen is set to "STEREO", only the audio of CH-1 is output from the monitoring speaker.
- CH-2 : The CH-2 channel audio is output.
- ☞ See "Outputting Audio" on page 53.
 ☞ See "AUDIO/MIC Menu Screen" on page 70.

CAUTION

Make sure to move switches all the way. Do not leave a switch stopped in a midway position. Noise will be generated and operation irregularities will occur.

- 16 [DISPLAY] Display button**
 Each time you keep pressing the DISPLAY button about 2 seconds, switch LCD monitor display and viewfinder display.
- 17 [VTR] VTR indicator**
 This indicator lights when the camera is in the VTR mode. To perform VTR playback or to input the HDV/DV signal from the IEEE1394 connector ④ on page 16, press the CAM/VTR button ⑤ on page 13 to turn on this indicator. It flashes when the mode is being changed. (DV signal input is possible with the GY-HD100U, GY-HD101E.)
- 18 [FULL AUTO] Full auto shooting (FAS) switch**
 This is the ON/OFF switch for FAS mode.
- During FAS mode, "FAS" is displayed on the LCD monitor or the viewfinder.
 - FAS mode works together with the auto iris and auto level control (ALC) modes and automatically adjusts to the optimal video signal level and white balance.
 - The audio recording level sets to automatic adjustment mode.
 - Even if there are color bars, this automatically sets to camera video.
 - SMOOTH TRANS mode does not run. ☞ See page 64.
 - Auto iris mode operates even if the lens iris mode switch is set to the manual position.
 - The gain changes continuously until it reaches the maximum ALC MAX setting, and the shutter speed also changes continuously.
 - When you release FAS mode, all of the settings return to their previous modes.

CAUTION

When the power is turned on while the camera is in the FAS mode, it takes about 10 seconds before the automatic adjustment of FAS is completed.

All of the previous setting contents are recalled when the FAS mode is cancelled.

- 19 [STOP] Stop button**
 Press to enter the stop mode.
- 20 [REW] Rewind button**
 Press this button to rewind the tape.
- Pressing this button in the stop or fast forward mode initiates the rewind mode. (Only for VTR mode)
 - Pressing this button during playback, still picture playback or forward search initiates reverse search.
- 21 [PLAY/STILL] Play/still button**
 Press to start playback. Press to enter the still picture mode during playback, in the stop mode or in the search mode.
- Depending on the ambient temperature, if still image playback mode continues for between 30 seconds and 3 minutes, it stops automatically. (Tape protect mode)
 During still picture playback and search mode, press this button to return to the normal playback mode.
- If the auto tracking is active at the moment the play mode is entered, the playback video will be interfered with digital noise.
- 22 [FF] Fast forward button**
 Press this button to fast forward the tape.
- Pressing this button in the stop or rewind mode initiates the fast forward mode. (Only for VTR mode)
 - Pressing this button during playback, still picture playback or reverse search initiates forward search.

Indications on the LCD Monitor and in the Viewfinder

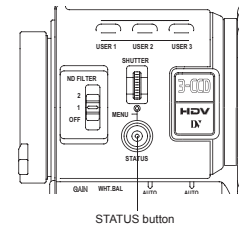
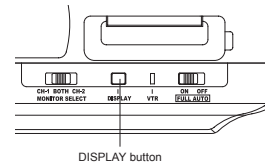

In addition to showing the EE image and the playback picture, the LCD monitor and viewfinder are also used for the following character displays.

To show characters on the LCD monitor, press the DISPLAY button briefly.

- Status screens (screens for checking the current camera settings)
- Auto white display (only displayed in the Camera mode)
- Menu setting screens
- Alarm message display
- Safety zone display (only displayed in the Camera mode)

MEMO

When the OUTPUT CHAR. item on the OTHERS [1/2] menu screen is ON, the menu setting screen is also displayed in the video from the video signal output connector.

■ Status Screens

- Press the STATUS button while normal screen is displayed to show one of the status screens.
- The contents of the status display are divided into those for the Camera mode and those for the VTR mode.
- Each time the STATUS button is pressed in the Camera mode, one of 5 status screens is displayed. (STATUS 0, 1, 2, 3, 4)
 - One type of screen is displayed in the VTR mode.

MEMO

- When the STATUS button is pressed for 1 second or longer, the menu setting screen is displayed. To display the Status screen while the menu setting screen is displayed, press the STATUS button to return to the normal screen.
- You can switch between the LCD monitor and the viewfinder by holding down the DISPLAY button for about 2 seconds.

• CAMERA MODE (display example)

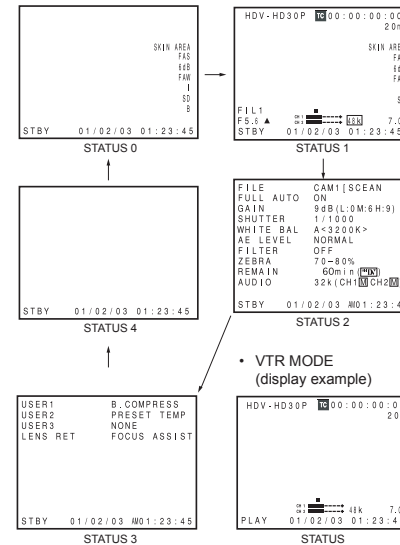

CONTROLS, INDICATORS AND CONNECTORS

Indications on the LCD Monitor and in the Viewfinder (Cont'd)

■ Status Screens in the Camera Mode

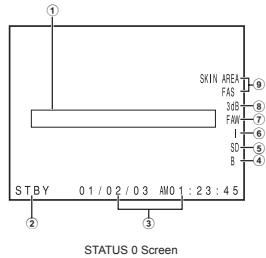

• STATUS 0

① Event Indication

When the Gain or Shutter Speed is changed manually, the setting condition is displayed for about 3 seconds at the time the change is made.

Setting Status	Contents of Indications
Gain value was changed	GAIN 0 dB, 3 dB, 6 dB, 9 dB, 12 dB, 15 dB, 18 dB
Gain value reached the ALC	GAIN ALC
FULL AUTO was turned ON/OFF	FULL AUTO ON, FULL AUTO OFF
ZEBRA was turned ON/OFF	ZEBRA ON, ZEBRA OFF
Shutter speed value was changed *1	SHUTTER 1/6, 1/6.25, 1/7.5, 1/12, 1/12.5, 1/15, 1/24, 1/25, 1/30, 1/48, 1/50, 1/60, 1/100, 1/120, 1/250, 1/500, 1/1000, 1/2000, 1/4000, 1/10000
Variable shutter speed value was changed *1	V. SHUTTER 1/24.01 to 1/1998.0
Shutter was turned OFF	SHUTTER OFF [1/**] *4
White balance value was changed	(Example) WHITE BAL A <3200K> Numeric value: Any of 2300, 2500, 2800, 3000, 3200, 3400, 3700, 4300, 5200, 5600, 6500, 8000
FILTER value was changed	FILTER OFF, FILTER ND 1 [1/4ND], FILTER ND 2 [1/16ND]
AE LEVEL value was changed *2	AE LEVEL -3, -2, -1, NORMAL, +1, +2, +3
BLACK gain value was changed *2	BLACK NORMAL BLACK STRETCH 1, 2, 3 BLACK COMPRESS 1, 2, 3
PRESET TEMP. value was changed *2 *3	WHITE BAL PRST <3200K>, WHITE BAL PRST <5600K>
HEADER REC is running	HEADER REC
FOCUS ASSIST was turned ON/OFF	FOCUS ASSIST ON, FOCUS ASSIST OFF
Timecode was set to zero reset	TC ZERO PRESET ⓘ See page 40.
REC LOCK switch was turned ON/OFF	REC SWITCH LOCKED, REC SWITCH UNLOCKED ⓘ See page 17, ⓘ REC LOCK switch.
A REC command was sent from the IEEE1394 connector	TRIGGER TO HDV, TRIGGER TO DV
Other Displays	ⓘ See "FILE MANAGE Menu Screen" on page 79-81. ⓘ See "Warnings and Responses" on page 85.

*1 The range for the shutter speed differs depending on the video format setting. ⓘ See page 69.

*2 Displayed if functions were assigned to the USER 1 - 3 buttons. ⓘ See page 69.

*3 Displayed when the [WHT.BAL] white balance selector switch ⓘ on page 15 is set to PRST (PRESET).

*4 " **" depends on the video format.

CONTROLS, INDICATORS AND CONNECTORS

No.	Item	Contents
②	VTR mode indication	STBY : In record standby mode (record-pause mode) REC : During recording PLAY : During playback FF : During fast forward REW : During rewind STL : During still picture playback mode FWD : During playback in forward direction (FWD1: About ×2 speed, FWD2: About ×5 speed, FWD3: About ×10 speed) REV : During playback in reverse direction (REV1: About ×2 speed, REV2: About ×5 speed, REV3: About ×10 speed) STOP : Stop mode (Tape protect mode) EJECT : Cassette being ejected --- : No tape loaded
③	Indication of date and time	Indicates the date and time. Whether or not the date and time should be displayed as well as the display style are set on the TIME/DATE menu.
	LCD BRIGHT indication	When the brightness of the monitor screen is adjusted with the LCD BRIGHT button, the date and time indications and the VTR mode indication ② are turned off and the LCD BRIGHT indicator is displayed. (Example) BRIGHT +5■■■■■■ Numeric value: Any of -5, -4, -3, -2, -1, 0, +1, +2, +3, +4, +5.
④	Indication of Black operation	B : Displayed when the black stretch or black compress settings are other than NORMAL.
⑤	Indication of skin tone detail operation	SD : Indicated when skin tone detail is ON.
⑥	Indication of Iris level operation	I : Displayed when the AE LEVEL setting is other than NORMAL
⑦	Indication of FAW operation	FAW : Indicated when Full Auto White Balance is ON.
⑧	Gain operation indication	* dB : Indicates gain value when gain is other modes than 0 dB and ALC.
⑨	Indication of various function operations	FOCUS : Displayed when the Focus Assist function is ON. SKIN AREA : Blinks while the skin detail color area is displayed. ALC : Displayed when ALC function alone is ON. FAS : Displayed when the Full Auto Shooting function is ON. S : Displayed when the SHUTTER function is ON.

CONTROLS, INDICATORS AND CONNECTORS

Indications on the LCD Monitor and in the Viewfinder (Cont'd)

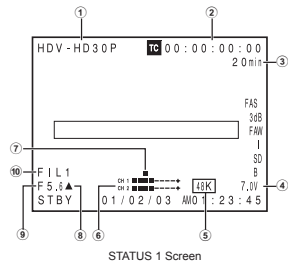

• STATUS 1

In addition to the information on the STATUS 0 screen, this screen displays the following items.

No.	Item	Contents
①	VIDEO FORMAT display	Displays the currently selected video format. Allows you to select the REC item on the VIDEO FORMAT menu screen. $\text{\textcircled{R}}$ See page 62. You can switch this display ON/OFF using the FORMAT item on the LCD/VF [2/3] menu screen. $\text{\textcircled{R}}$ See page 72.
②	Time Code (TC)/User's Bits (UB) indication	Indicates the time code (h:m:s:frame) or user's bits data. (Example) Time code TC 00 : 00 : 00 [] 00 Colon (:) when non-drop frame mode Dot (.) when drop frame mode User's bits UB FF EE DD 20 Whether or not to display this item is set with the TC/UB item on the LCD/VF [2/3] menu screen. $\text{\textcircled{R}}$ See page 72. Whether the time code or user's bits should be shown is selected with the TC DISPLAY switch inside the LCD door.
③	Remaining tape indication	Remaining tape indication (displayed in 1-minute steps) This indicator blinks when remaining tape time is equivalent to less than 3 minutes. Whether or not to display this item is set with the TAPE REMAIN item on the LCD/VF [2/3] menu screen. $\text{\textcircled{R}}$ See page 72. * When inserting a brand-new tape, the remaining tape time is not indicated. When the tape has been run, the indication will appear. * The remaining tape indication is to be regarded only as a guide. * When the unit is used at low temperatures, it may take a while before the indication of the remaining tape time appears.
④	Voltage indication	(Example) 7.0V: Indicates remaining battery level in 0.1V steps.

CONTROLS, INDICATORS AND CONNECTORS

No.	Item	Contents
⑤	Audio sampling frequency indication	32 K : Indicated when the AUDIO MODE item on the AUDIO/MIC menu screen is set to 32 K. (Audio is recorded with 12-bit, 32 kHz sampling.) 48 K : Indicated when the AUDIO MODE item on the AUDIO/MIC menu screen is set to 48 K. (Audio is recorded with 16-bit, 48 kHz sampling.) $\text{\textcircled{R}}$ See page 70.
⑥	Audio level meter indication	Displays the CH-1, CH-2 audio level meters. Whether or not to display this item is set with the AUDIO item on the LCD/VF [2/3] menu. $\text{\textcircled{R}}$ See page 72.
⑦	Standard audio level indication	The level at which audio is recorded on the tape is indicated by "■". -20 dB, -12 dB $\text{\textcircled{R}}$ See "AUDIO REF.LEVEL" on page 70.
⑧	Iris indicator display	▲ : Iris set higher than normal ■ : Iris set to normal ▼ : Iris set lower than normal
⑨	Iris F-value indication	Indicates the F-number of the connected lens. OPEN, F2, F2.8, F4, F5.6, F8, F11, F16, CLOSE It is not displayed when the lens is removed. For some lenses, no display appears. The indication can be switched ON/OFF with the F.NO/IRIS IND. item on the LCD/VF [1/3] menu screen. $\text{\textcircled{R}}$ See page 71.
⑩	Filter position indication	Indicates the current filter position. No display: FILTER OFF ND1: FILTER ND1 (1/4ND) ND2: FILTER ND2 (1/16ND) The indication can be switched ON/OFF with the FILTER item on the LCD/VF [1/3] menu screen. $\text{\textcircled{R}}$ See page 71.

CONTROLS, INDICATORS AND CONNECTORS

Indications on the LCD Monitor and in the Viewfinder (Cont'd)

FILE	CAM1 [SCEAN]
FULL AUTO	ON
GAIN	9dB (L:0M:6H:9)
SHUTTER	1/1000
WHITE BAL	A<3200K>
AE LEVEL	NORMAL
FILTER	OFF
ZEBRA	70-80%
REMAIN	60min ([])
AUDIO	32k (CH1 [] CH2 [])
STBY	01/02/03 MO1:23:45

STATUS 2 Screen

USER1	B.COMPRESS
USER2	PRESET TEMP
USER3	NONE
LENS RET	FOCUS ASSIST
STBY	01/02/03 MO1:23:45

STATUS 3 Screen

• STATUS 2

This screen displays the camera setup statuses.
Event display is not available while this screen is displayed.

Indication	Indication Contents
FILE	FILE ● CAM1 [*****], CAM2 [*****], and EXT1 - 4 [*****] * indicates SUB NAME ☞ See page 79-81. A ● symbol is displayed when a menu setting read from LOAD FILE was changed. The display disappears when the setting is saved using STORE FILE.
FULL AUTO	ON, OFF
GAIN	0dB, 3dB, 6dB, 9dB, 12dB, 15dB, 18dB, ALC
SHUTTER	(When STEP is selected) OFF, 1/6, 1/6.25, 1/7.5, 1/12, 1/12.5, 1/15, 1/24, 1/25, 1/30, 1/48, 1/50, 1/60, 1/100, 1/120, 1/250, 1/500, 1/1000, 1/2000, 1/4000, 1/10000 (When VARIABLE is selected) 1/24.01 - 1/1998.0 (Displayed when FAS or ALC mode is selected) EEI *The range for the shutter speed differs depending on the video format. ☞ See page 69.
WHITE BAL	A<##00K>, B<##00K>, PRESET<##00K>, FAW
AE LEVEL	-3, -2, -1, NORMAL, +1, +2, +3
FILTER	OFF, ND1 (1/4ND), ND2 (1/16ND)
ZEBRA	60-70%, 70-80%, 85-95%, OVER 95%, OVER 100%
REMAIN	Displays the remaining tape (minutes) and the type of tape (Ex: 60MIN ([])) [] (Mini DV Videocassette)
AUDIO	Displays the audio sampling frequency and the audio level adjustment mode (Ex: 32K (CH1 [] CH2 []) [] (for AUTO mode) [] (for MANUAL mode))

• STATUS 3

Displays a list of setting statuses for USER1, 2, and 3 as well as LENS RET item on the SWITCH MODE menu screen.
☞ See page 69.
Events are not displayed while these statuses are being displayed.

Indication	Indication Contents
USER1	NONE, BARS, PRESET TEMP., B.STRETCH1, B.STRETCH2, B.STRETCH3, B.COMPRESS1, B.COMPRESS2, B.COMPRESS3, AE LEVEL+, AE LEVEL-
USER2	NONE, BARS, PRESET TEMP., B.STRETCH1, B.STRETCH2, B.STRETCH3, B.COMPRESS1, B.COMPRESS2, B.COMPRESS3
LENS RET	RET, FOCUS ASSIST

• STATUS 4

This screen only displays VTR mode indication, date and time, event display and alarm indications.
* Whether or not date and time should be displayed and the display style are set on the TIME/DATE menu screen.
☞ See "Displaying the Time and Date on the Screen" on page 37.

CONTROLS, INDICATORS AND CONNECTORS

■ Status Screen in VTR MODE

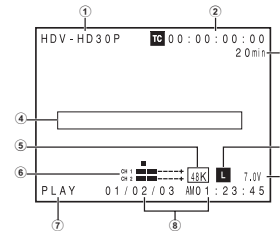

No.	Item	Contents
①	VIDEO FORMAT display	Displays the video format recorded on the tape when in VTR mode. You can switch this display ON/OFF using the VIDEO FORMAT item on the LCD/VF [2/3] menu screen. ☞ See page 72. MEMO This camcorder cannot play back or output tape recorded in HDV 1080i format. "INVALID TAPE!" is displayed in the event display area (4).
②	Time code (TC) and user's bits (UB) display	Displays the time code data being recorded (hour, minute, second, frame) when in VTR mode. You can switch this display ON/OFF using the TC/UB item on the LCD/VF [2/3] menu screen. ☞ See page 72. You can select to display either the time code or the user's bits using the TC DISPLAY switch in the LCD door.
③	Remaining tape time	Remaining tape indication (displayed in 1-minute steps) This indicator blinks when remaining tape time is equivalent to less than 3 minutes. Whether or not to display this item is set with the TAPE REMAIN item on the LCD/VF [1/2] menu screen. ☞ See page 72. * When inserting a brand-new tape, the remaining tape time is not indicated. When the tape has been run, the indication will appear. * The remaining tape indication is to be used only as a guide. * When the unit is used at low temperatures, it may take a while before the indication of the remaining tape time appears.
④	Event display	Displays messages related to VTR operations. ☞ See page 85-86.
⑤	Audio sampling frequency indication	The audio sampling frequency used for the recording is displayed during playback. (32 K, 48 K, 44.1 K)
⑥	Audio level meter indication	Displays the audio level meters during playback. Whether or not to display this item is set with the AUDIO item on the LCD/VF [2/3] menu screen. ☞ See page 72.
⑦	VTR mode indication	Indicates the VTR operation status STBY, STOP, PLAY, REC, FF, REW, FWD, REV, STL, --- (No tape loaded), SLOW: During variable playback in forward direction (Displayed when using non-linear editing software.) (SLOW+1: About ×0.1 speed, SLOW+2: About ×0.2 speed, SLOW+3: About ×0.5 speed) During variable playback in reverse direction (Displayed when using non-linear editing software.) (SLOW-1: About ×-0.1 speed, SLOW-2: About ×-0.2 speed, SLOW-3: About ×-0.5 speed)
⑧	Time/Date indication	Recorded data are displayed during playback, fast forward, and rewind. During recording, the data from the IEEE1394 connector is displayed. (GY-HD100U/GY-HD101E only) Whether or not the date and time should be displayed and the display style are set on the TIME/DATE menu screen. ☞ See page 76. When the date and time have not been set, the following indication appears. - - - - -
⑨	Voltage indication	(Example) 7.0V : Indicates remaining battery level in 0.1V steps.
⑩	Audio Lock indication	Displayed when the audio signal from DV recording or playback is locked to the video signal.

Indications on the LCD Monitor and in the Viewfinder (Cont'd)

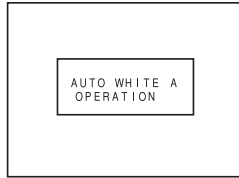

■ Auto White Balance Indication (Camera mode only)

The AUTO WHITE indication and the result of the operation are displayed during the auto white balance adjustment operation.
 ☞ See "White Balance Adjustment" on page 43.

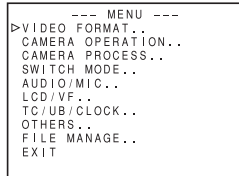

TOP MENU screen (Camera mode)

■ Menu Setting Screen

Screen used for making various settings. The Menu Setting Screen appears when the STATUS button is pressed for 1 second or more.
 ☞ See "Setting Menu Screens" on page 60.

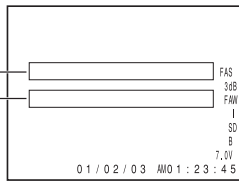

Alarm display area

■ Alarm Message Display

- The following alarm messages are displayed while the STATUS (0, 1, 4) screen is shown in the Camera mode, or a STATUS screen is shown in the VTR mode. If an alarm is generated while the STATUS 2, 3 screen is shown, the STATUS 0 screen returns to display the alarm.
 ☞ See page 85.
- When an abnormality occurs in the VTR, a warning message with an error code is displayed.
 ☞ See page 85-86.

■ Safety Zone Indication (Camera mode only)

The indication of the following safety zone and center mark indications can be turned ON/OFF with the SAFETY ZONE item and CENTER MARK item on the LCD/VF [1/3] menu screen. ☞ See page 71. In addition, the safety zone display is on or off depending on the REC item setting and the ASPECT item setting in the VIDEO FORMAT menu screen, as shown below.

SAFETY ZONE		OFF	4:3		14:9		16:9		16:9+4:3	
CENTER MARK		-	OFF	ON	OFF	ON	OFF	ON	OFF	ON
REC	ASPECT									
DV-60i DV-24P DV-24PA DV-50i DV-25P	4:3	[]	[]	[+]	[-]	[+]	[-]	[+]	Cannot be selected	
	16:9	[]	[]	[+]	[-]	[+]	[-]	[+]		
HDV-SD60P HDV-SD50P HDV-HD30P HDV-HD25P HDV-HD24P	[16:9]	[]	[]	[+]	[-]	[+]	[-]	[+]	[]	[+]

The LCD monitor and the viewfinder (VF) display are on or off depending on whether the LCD monitor is open or closed as well as normal or inverted, as shown below.

LCD Monitor Status	LCD Display	LCD Display	VF Display
LCD Closed	Normal LCD	OFF	ON
	Inverted LCD	ON	OFF
LCD Open	Normal LCD	ON	OFF
	Inverted LCD	ON	OFF

MEMO

- You can switch between the LCD monitor and the viewfinder by holding down the DISPLAY button for about 2 seconds.
- After you set up the function that switches the display between the LCD monitor and the viewfinder by holding down the DISPLAY button, the display mode is cancelled by the LCD monitor open/close and normal/inverted operations.
- If the LCD monitor is closed inside the camcorder with the screen in the normal display orientation, holding down the DISPLAY button does not work.

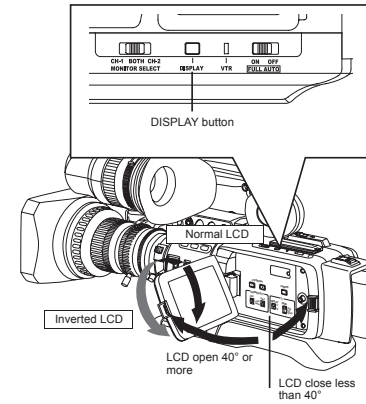

PREPARATIONS

Basic System

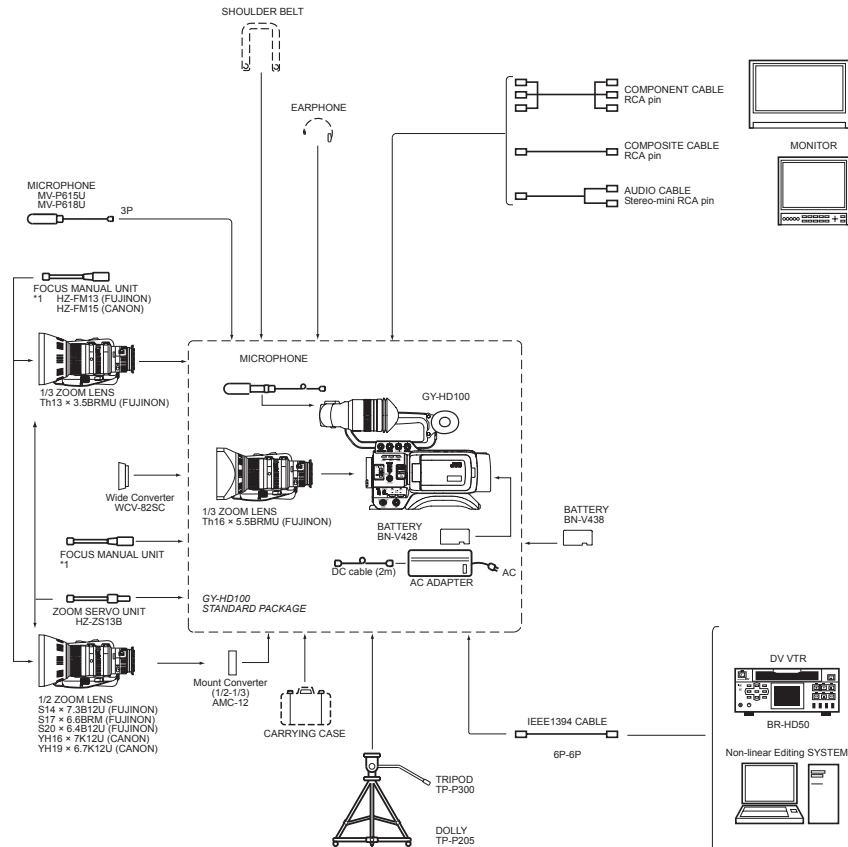

*1 An HZ-FM13 cannot be used with a Th16x5.5BRMU or S14x7.3B12/U zoom lens. Use a FUJINON focus manual unit (FMM-8, CFH-3, CFC-12-990). For details, please consult your JVC authorized dealer.

PREPARATIONS

Attaching the Zoom Lens (Provided)

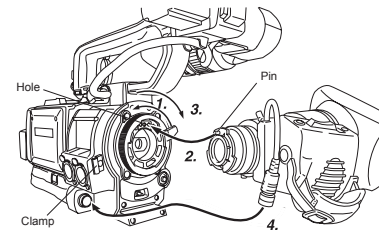

1. Loosen the mount ring.
2. Attach the lens with its pin aligned with the hole in the mount.
3. Tighten the mount ring.
4. Connect the cable connector.
5. Clamp the lens cable.

CAUTION

- Be sure to tighten the mount ring completely. Incomplete tightening may result in the lens dropping off or disturbed back focus.
- Set the GY-HD100's power switch to "OFF" before the zoom lens is attached or detached.

Attaching the Microphone (Provided)

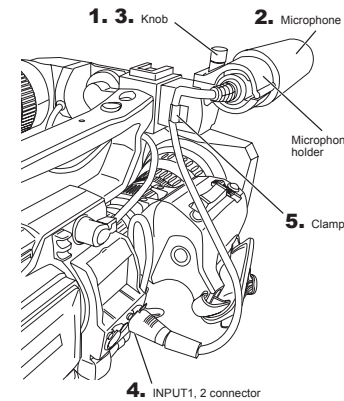

Connect the provided microphone to the microphone holder. Provided microphone is a phantom microphone.

1. Turn the knob on the microphone holder anticlockwise to loosen it and open the microphone holder.
2. Place the microphone in the microphone holder. Place the microphone toward the front to prevent it from interfering with the cassette cover.
3. Turn the knob on the microphone holder clockwise to secure the microphone.
4. Connect the microphone cable to the INPUT1 or INPUT2 input connector on the GY-HD100.
5. Attach the microphone cable to the clamp.
6. Make sure to perform the correct setting for use of a phantom microphone. See page 46.

How to Attach the Viewfinder

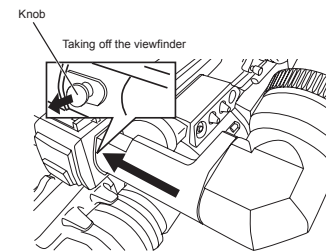

To attach the viewfinder, slide it in the direction of the arrow.

To take off the viewfinder, pull the knob in the direction of the arrow as you slide the viewfinder.

Inserting an SD Memory Card

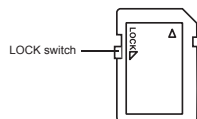
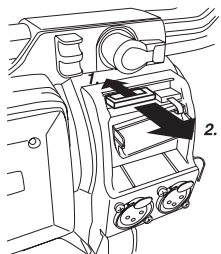
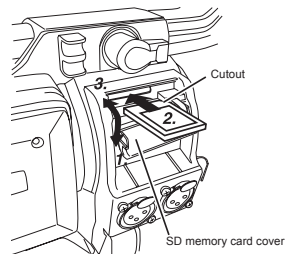

By using an SD memory card, you can save and call up menu settings and camera settings for this camcorder.

☞ See "FILE MANAGE Menu Screen" on page 79.

Check that the **POWER switch is OFF**.

■ Inserting an SD Memory Card

1. Open the SD memory card cover.
2. Face the cutout end of the SD memory card inward and insert it in the direction of the arrow.

CAUTION

Be sure not to touch the metal connector area of the SD memory card.

3. Close the SD memory card cover.

■ Taking out the SD memory card

1. Push the SD memory card in the direction of the arrow.
 - The SD memory card comes out slightly.
2. Pull the SD memory card straight out.

■ About SD Memory Cards

- When you use an SD memory card that was either just purchased or formatted on a device other than this camcorder, format it on this camcorder.
 - ☞ See page 81.
- Recommended SD memory cards
Panasonic: 32 MB or more

- You can write-protect the card so that saved files are not mistakenly erased. Set the switch on the side of the SD memory card to the "LOCK" position.

About the Viewfinder Cable

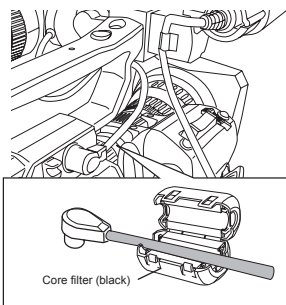

To reduce the emission of unwanted radio waves, be sure to attach the provided core filter as shown in the figure on the left.

- Attach the core filter (black) as close to the camcorder as possible, as shown in the figure.

AC Operation

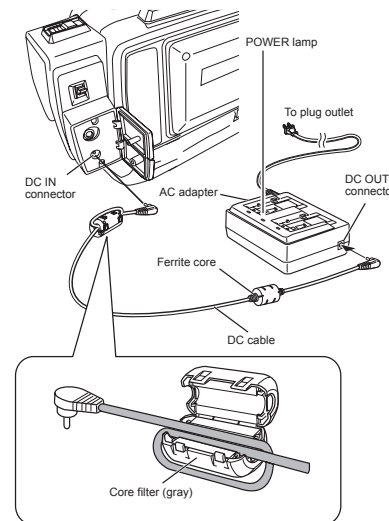

The GY-HD100 is operable with AC power supply or battery pack.

Use the supplied AC adapter as the AC power supply.

1. After making sure that the power switches of the GY-HD100 and of the AC adapter are set to OFF, connect the DC cable from the AC adapter to the DC IN connector of the GY-HD100 as shown in the illustration.
2. Press the POWER switch of the GY-HD100 to ON. Power is supplied to the VTR section and the camera.

CAUTION

- When using the DC cable make sure to connect the end of the cable with the ferrite core to the AC adapter.
- Do not remove or connect the DC cable while recording is being performed.
- Do not use any power source with large fluctuations in the power source voltage, power sources generating noise, such as ripples or power sources with lower voltage.

Attach the supplied core filter (gray) as shown in the diagram on the right to reduce unwanted electromagnetic emission.

- Attach the core filter as shown in the diagram on the left to this unit as near as possible.

■ Charging the Built-in Battery

The built-in, rechargeable backup battery retains the date and time and the time code data.

The built-in battery is constantly being charge whenever the GY-HD100 is connected to a power supply, but it gradually discharges while the GY-HD100 is disconnected from a power supply. The battery will be fully discharged when the GY-HD100 is not used for about three months, in which case the set date and time and time code data are reset.

In this case, recharge the built-in battery and then set the date and time and time code data again.

However, it is possible to use the GY-HD100 even if the built-in battery is discharged but the date and time and time code data cannot be recorded.

■ How to charge

1. Connect the provided AC adapter to the GY-HD100 and an AC outlet or mount a charged battery on the GY-HD100.
2. Set the POWER switch on the GY-HD100 to "ON" or "OFF" (charging takes places with the POWER switch set to either of the positions.)
3. Leave the equipment in this condition for about 4 hours.
 - The built-in battery will remain charged for about 3 months after being charged for about 4 hours.

PREPARATIONS

Battery Operation

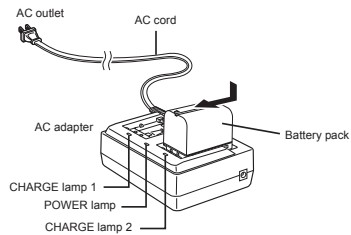

■ Charging the Battery Pack

Before use the battery pack should be charged using the provided AC Adapter.

* Be sure to pull the DC cable out of the AC adapter when you charge the battery.

1. Plug the AC cable of the AC Adapter into an AC outlet. The POWER lamp illuminates.
2. While pushing the battery pack down, slide it in the direction of the arrow to mount it on the AC Adapter. Charging starts, and the CHARGE lamp blinks green. It changes to light steadily when charging is completed.
3. When charging is completed, remove the battery pack by sliding it in the opposite direction of the mounting direction.

■ Attaching the Battery Pack on the GY-HD100

If the DC cable is connected to the GY-HD100, unplug the cable.

1. Hold the battery pack with the connector side facing the GY-HD100.
2. While pressing the battery pack against the GY-HD100, slide it downward to attach it to the GY-HD100.

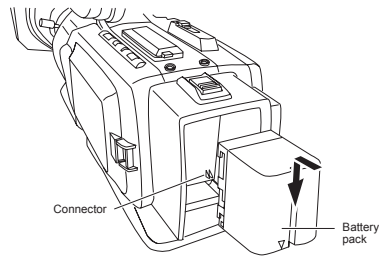

■ Detaching the Battery Pack from the GY-HD100

Ensure that the POWER switch on the GY-HD100 is set to OFF.

1. While sliding the battery pack lock release lever, slide the battery pack upward to remove it.

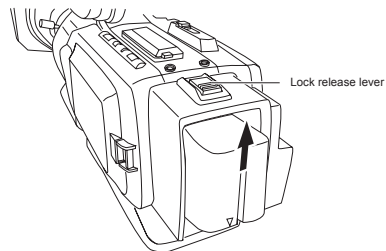

CAUTION

Do not detach the battery pack while recording is taking place.

MEMO

- Do not connect or disconnect the DC cable while operating with a battery pack. The following symptoms may occur if the DC cable is connected or disconnected while operating with a battery pack.
 - The power is cut off for a moment when the DC cable is disconnected.
 - Noise to the video and audio signals occurs. Audio signals are muted.
- When operation is continued with DC input after the battery pack capacity has been used up, set the POWER switch to OFF after the DC power is applied. Then switch ON again.
- If the GY-HD100 is left with the battery pack attached, a small amount of power is consumed even if the POWER switch on the GY-HD100 is set to OFF. Remove the battery pack when the GY-HD100 is not going to be used.

PREPARATIONS

■ Remaining Battery Power Display

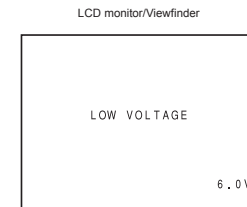

When the remaining battery power is nearly exhausted, the following warnings will be generated.

- Viewfinder screen or LCD monitor
 - When a Status screen is displayed (excluding the STATUS 2, 3 screen in the Camera mode)
 - Alarm indication: LOW VOLTAGE displayed.
- FRONT and BACK TALLY lamp on camera: Blinks
- Monitoring loudspeaker and PHONES jack: Alarm sound

MEMO

After the remaining battery power warnings appear, the GY-HD100 automatically stops operation if the battery power operation is continued.

■ Battery Recharge Times

Battery pack	Recharging time of a single pack	Successive recharging time of two packs
BN-V428	Approx. 3 hr. 20 min	Approx. 6 hr. 40 min
BN-V438	Approx. 4 hr. 20 min	Approx. 8 hr. 40 min

- When charged at temperatures between 20°C (68°F) and 25°C (77°F).
- When charging battery packs after a long storage period, charging time will be longer than indicated above.
- When two battery packs are attached, they will be recharged in the order that they are attached.

■ Operating Time with Battery Pack

When a fully charged battery pack is attached, the approximate continuous operating time is as follows

Battery Pack	Continuous Operating Time (at 25°C)
BN-V428	Approx. 40 minutes
BN-V438	Approx. 60 minutes

- Battery operating time may differ depending on the age of the battery pack, charging conditions and the operating environment, etc. Use the values in the table on the above for approximate reference times.
- Operating time is reduced in areas with a cold environment.
- Operating time is reduced when the power zoom lens and LCD are used frequently.

■ Precautions for the Battery Pack

- When the battery pack is not in use, it must be stored in a cool, dry place. Do not leave the battery pack in a place where it might be subject to a high temperature (under direct sunlight in a car, etc.), this could cause leakage of the fluid or shorten service life.
- When the terminal section of the battery pack gets dirty, the operating time will be shortened.
- If the operating time becomes greatly reduced even immediately after recharging, the service life of the battery pack is nearly finished. Purchase a new battery pack.

■ Recharging

- Recharge the battery pack after completely discharging it. Repeated recharging with residual charge remaining could result in reduced battery capacity.
- If the battery capacity is reduced by repeating incomplete recharging, or recharging without discharging, once discharge the battery pack completely, then recharge it to restore the battery capacity.
- If the battery pack is recharged with its internal temperature raised immediately after use, recharging may not be performed completely.
- Perform charging in an environment where the temperature is between 10°C (50°F) and 35°C (95°F). 20°C (68°F) to 25°C (77°F) is the ideal temperature range for charging. If the environment is too cold, charging may not complete.

PREPARATIONS FOR OPERATION

Turning the Power ON

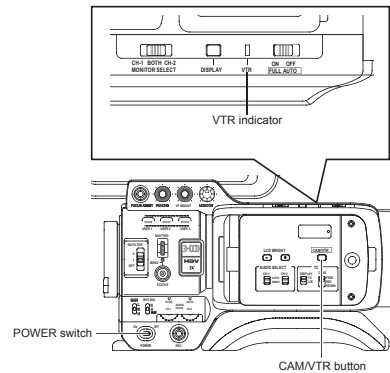

Turning the Power ON

1. Set the POWER switch to ON.
The unit turns on in Camera mode.

The operation differs according to whether the unit is in the Camera mode or in the VTR mode. The mode switches each time you press the CAM/VTR button.

When the mode is switched, the VTR indicator displays the following statuses.

While the mode is being switched : Flashing
In VTR mode : Lit
In Camera mode : Off

Camera mode

The GY-HD100 enters the Camera mode. The camera image is displayed in the viewfinder or on the LCD monitor. When a recordable videocassette is loaded, the GY-HD100 enters the record-standby mode automatically. "STBY" is displayed in the VTR operation mode indication area of the LCD monitor or in the viewfinder. In this condition, press the REC/VTR trigger button to start recording.

* Playback is also possible in the Camera mode.

Playback operation becomes possible when the STOP button is pressed to set the VTR operation mode indicator to indicate "STOP".

VTR mode

The GY-HD100 enters the VTR mode. The camera image will not be displayed in the viewfinder or on the LCD monitor. When a videocassette is loaded, the GY-HD100 enters the stop mode.

"STOP" is displayed in the VTR operation mode indication area of the LCD monitor or in the viewfinder.

HDTV/DV input is possible through the IEEE1394 connector. (GY-HD100U/GY-HD101E only)

Turning the Power OFF

1. Place the GY-HD100 in the record-standby or STOP mode.
2. Set the POWER switch to OFF.
3. Remove the battery pack or the power supply to the DC IN connector. (When the camera is not going to be used for a longer period.)

CAUTION

- Do not set the POWER switch to OFF while recording is taking place. Confirm that the "STBY" or "STOP" indication is shown in the VTR operation mode indication area before the power is turned off. Should the POWER switch accidentally be set to OFF during a recording, wait at least 5 seconds before turning the power on again.
- Always set the POWER switch to OFF before disconnecting the power supply. Do not turn the battery pack or AC power supply OFF while the POWER switch on the camera is still set to ON.

PREPARATIONS FOR OPERATION

Loading/Unloading the Cassette

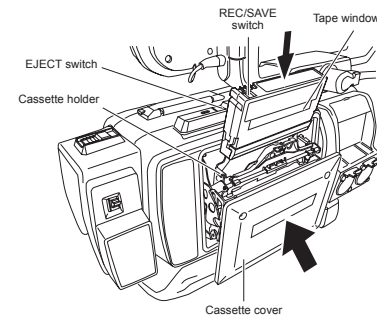

Cassette Loading

Use a videocassette tape marked MiniDV.

- To record, slide the switch on the back for use in preventing accidental erasure to the "REC" side.
 - Remove any the tape slack before loading.
1. Turn the POWER switch ON.
 2. Slide the EJECT switch on the top panel of the camcorder to the side. The videocassette cover opens automatically and a videocassette tape can be inserted.
 3. Insert a videocassette tape into the videocassette holder. With the tape window facing out, move the switch on the back of the videocassette up and firmly push the center back of the videocassette straight in as far as it will go.
 4. Carefully push the center of the videocassette cover in the direction of the arrow as far as it will go to close it.
 - After the cover is closed, it takes about 10 seconds until recording can begin or the camcorder can enter stop mode.
- If the power is on, the modes are as shown below.

MODE	REC/SAVE switch	
	REC	SAVE
Camera	Record-standby mode	STOP mode REC INHIBIT is displayed on the LCD monitor and in the viewfinder.
VTR	STOP mode	

Unloading the Cassette

1. Turn the POWER switch to ON.
2. When the camcorder is in shooting standby mode or stop mode, slide the EJECT switch to the side and wait until the videocassette cover opens completely.
 - The LED next to the EJECT switch flashes. A few seconds pass before the videocassette tape is ejected.
3. The LED turns off and the videocassette cover opens.
 - Take out the videocassette tape.
4. Carefully push the center of the videocassette cover in the direction of the arrow as far as it will go to close it.

CAUTION

- When you close the videocassette cover, push it in firmly as far as it will go. If the videocassette cover is not closed properly, it becomes half-locked and the camcorder cannot function. If this happens, firmly push the videocassette cover in again as far as it will go to lock it.
- Do not slide the EJECT switch while recording is in progress. If you slide the EJECT switch while recording is in progress, the tape is ejected.
- Do not leave the videocassette cover open for a long time. Dust or dirt may enter the inside and cause damage.
- Do not touch the videocassette cover or interfere with the eject operation while ejecting is in progress. This will cause damage.

PREPARATIONS FOR OPERATION

Setting and Displaying the Date and Time

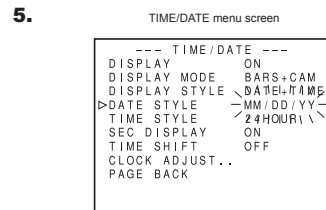
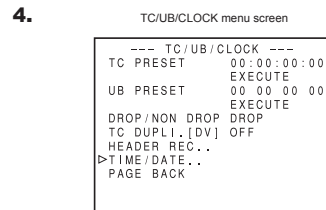
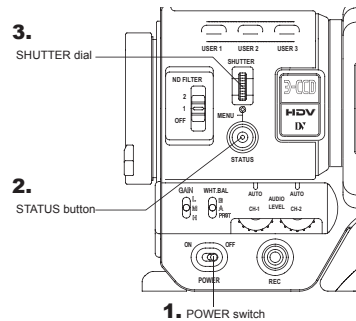

The date and time of the built-in clock should be set. Powered by the built-in backup battery the set date and time data continue to count even when the power is switched off.

- The set date and time data are displayed on the LCD monitor or in the viewfinder and recorded on the tape in accordance with the settings made on the menu screen.

■ Setting the Date and Time Style

The date and time are set on the menu screen. When setting while observing on a monitor connected to the connector, set the OUTPUT CHAR. item on the OTHERS [1/2] menu screen to ON.

- Set the POWER switch to ON.
- Press the STATUS button for 1 second or longer to display the TOP MENU screen.
- Rotate the SHUTTER dial to align the cursor (▶) with the TC/UB/CLOCK item, and then press the SHUTTER dial.
 - The TC/UB/CLOCK menu screen appears.
- Rotate the SHUTTER dial to align the cursor (▶) with the TIME/DATE item, and then press the SHUTTER dial.
 - The TIME/DATE menu screen appears.
 - Set the DISPLAY item on the TIME/DATE menu screen to ON.
- Make settings on the TIME/DATE menu screen. (This includes display style, etc.)

- DATE STYLE : Selects the style for displaying the date.
 YY/MM/DD (Year, month, day)
 MM/DD/YY (Month, day, year)
 DD/MM/YY (Day, month, year)
- TIME STYLE : The time can be set to display as a 12-hour or 24-hour clock system.
- SEC DISPLAY : To select whether or not indication of seconds should be displayed on the screen.
- TIME SHIFT : Adds time to the built-in clock (time compensation) and displays it. The adjusted time is also recorded on the tape.

- Rotate the SHUTTER dial to align the cursor (▶) with the item to be set, and then press the SHUTTER dial.
 - The setting area of the selected item starts blinking.
- Rotate the SHUTTER dial to change the setting, and then press the SHUTTER dial.
 - The setting area stops blinking and the setting is entered.

MEMO

The TIME STYLE, SEC DISPLAY, DATE STYLE and TIME SHIFT items can also be set and changed after the date and time have been set.

PREPARATIONS FOR OPERATION

■ Setting the Date and Time

- Display the CLOCK ADJUST menu screen. Select the CLOCK ADJUST item on the TIME/DATE menu screen.
- Set the date and time. The blinking digit is the one to be set.
 - When the SHUTTER dial is pressed, the blinking digit moves to the next digit.
 - When the SHUTTER dial is rotated, the value of the blinking digit changes. When the SHUTTER dial is rotated upward, the value becomes higher. When rotated downward, the value becomes smaller.
 - Repeat the procedure described in ① and ② above to set the day, month, year, hours, minutes.
 - Press the SHUTTER dial in sync with a time signal to enter the date and time precisely.
- When all the settings are completed, rotate the SHUTTER dial to align the cursor with the PAGE BACK item, and then press the SHUTTER dial.
 - The TIME/DATE menu screen returns.
- To return to the normal screen, use either of the following methods. Press the STATUS button or Return to the TOP MENU screen and then select the EXIT item on the TOP MENU screen before pressing the SHUTTER dial.

■ Displaying the Time and Date on the Screen

Whether or not the time and date should be displayed on the screen and how to display them are set on the TIME/DATE menu screen.

- Display the TIME/DATE menu screen.
 - Select the TC/UB/CLOCK item on the TOP MENU screen.
 - Select the TIME/DATE item on the TC/UB/CLOCK menu screen.
- Set the TIME/DATE menu screen.
 - DISPLAY item : Sets whether or not date and time should be displayed. Set to ON to display the indications.
 - DISPLAY MODE : Sets the video output mode in which date and time should be displayed.
 - BARS : Displayed when outputting the color bar.
 - CAM : Displayed when outputting the color camera image.
 - BARS+CAM : Date and time are always displayed.
 - DISPLAY STYLE : Sets the style in which the date and time are displayed.
 - DATE+TIME : Date and time are displayed.
 - DATE : Date only is displayed.
 - TIME : Time only is displayed.

- Display of date and time in the various operation modes.
- In Camera mode : The date and time of the internal clock are displayed.
 - In VTR playback mode : The date and time recorded on the tape are displayed.
 - In VTR stop mode : The last read date and time values are displayed.
- When an HDV/DV signal is input from the HDV/DV input. (GY-HD100U/GY-IEEE1394 connector)

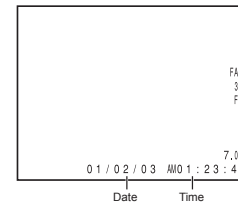
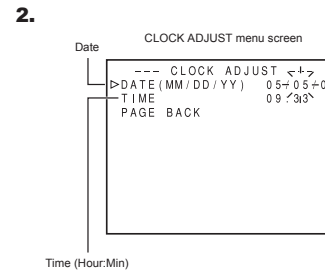
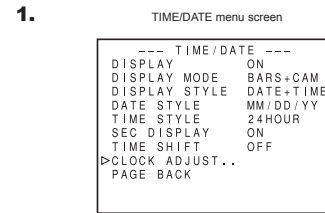

Displaying Time Code

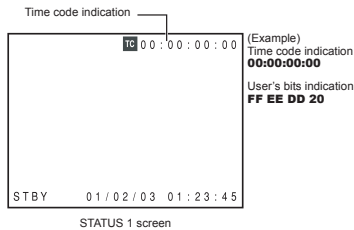
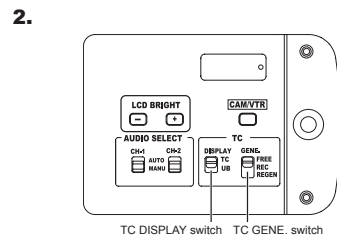
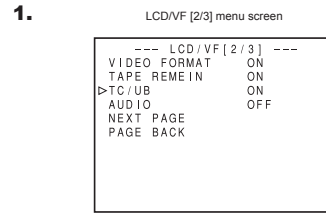

The GY-HD100 records SMPTE-standard (NTSC) or EBU-standard (PAL) time codes and user's bits. In the play mode or the record mode, the reproduced time codes or user's bits are shown on the LCD monitor or in the viewfinder.

- Time code data cannot be output through the unit's connectors.

The time codes or user's bits can be shown on the LCD monitor or in the viewfinder during playback and recording as follows. (Status screen)

■ Setting

- Set the TC/UB item on the LCD/VF [2/3] menu screen to ON.
 - Time codes or user's bit data are displayed on the STATUS screen.

- Whether time codes or user's bit data should be displayed is selected with the TC DISPLAY switch inside the LCD door.

TC : Time codes are displayed.
 UB : User's bit data is displayed.

■ Time code input entered the IEEE1394 connector (GY-HD100U/GY-HD101E only)

Pressing the STOP button for 1 second in the EJECT or stop mode displays the DV input time code data or user's bit data from the IEEE1394 connector on the STATUS screen.

DTCG : The time code data from the IEEE1394 connector
 DUBG : The user's bit data from the IEEE1394 connector

To return to display of the original time code or user's bit, press the STOP button. (Display of the normal time code or user's bit is also restored by performing VTR operation.)

MEMO

- To record DV input time cord and user's bit from the IEEE1394 connector, set the TC DUPLI. [DV] item on the TC/UB/CLOCK menu screen to ON.
- See page 74.
- To maintain the continuity of time code data, use with the TC GENE. switch set to REGEN mode when recording DV input signal from the IEEE1394 connector.
- There is no timecode display for HDV input.

CAUTION

A time code with a duration of more than 2 hours may not be displayed correctly by DV components for general consumer use, as some of these lack the capability to display longer time codes.

Recording Time Codes in Continuation of Time Codes Recorded on Tape

The GY-HD100 also incorporates a time code reader. Therefore, when the unit enters record mode from record-standby mode, it can read the time code data recorded on the tape and record time codes in continuation of the existing data. The recorded user's bit data are identical to the user's bit data recorded on tape.

* However, approximately ±1-frame variations may occur in scene accuracy.

To enable this function, set the time code related switches as follows before starting recording.

■ Setting

Set the TC GENE. switch inside the LCD door to REGEN.

MEMO

The time code framing mode automatically becomes the mode (drop frame or non drop frame) already recorded on the tape.

Presetting and Recording of Time Code

TC/UB/CLOCK menu screen (FRAME RATE: 60/30)

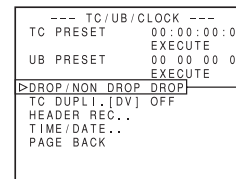

Framing mode:
 Drop frame/
 Non-drop setting

TC/UB/CLOCK menu screen (FRAME RATE: 50/25)

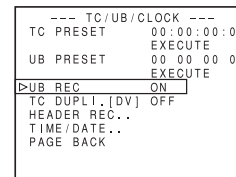

The time codes from the internal time code generator can be recorded at the time of recording scenes.

- The TC/UB/CLOCK menu screen differs depending on whether the FRAME RATE item on the VIDEO FORMAT menu screen is "60/30" or "50/25".

To preset the Time Code, make the following settings.

■ TC GENE. switch

Set to REC or FREE.

REC : The data preset in the time code generator runs only during recording.

Use this setting if it is necessary to record continual time codes across different scenes.

* However, approximately ±1-frame variations may occur in scene accuracy.

FREE : The time code starts to run from the time it is preset in the time code generator.

■ TC/UB/CLOCK menu screen (FRAME RATE: 60/30)

Use the DROP/NON DROP item to select the framing mode for the time code generator.

DROP : The time code generator's running method is set the drop frame mode.

Use this setting when placing emphasis on the recording time.

NON DROP : The time code generator's running method is set to the non drop frame mode.

Use this setting when placing emphasis on the number of frames.

MEMO

Drop frame/Non-drop frame mode

In the NTSC system, the actual number of frames per 1 second is approximately 29.97 frames, but per time code 30 frames are processed. To compensate for this difference, the mode called "drop mode" drops frame 00 and 01 for every minute not divisible by 10.

The "non-drop frame mode" is when no frames are dropped and the actual time shift neglected.

■ TC/UB/CLOCK menu screen (FRAME RATE: 50/25)

Whether or not user's bit data should be recorded can be selected with the UB REC item on the TC/UB/CLOCK menu screen.

PREPARATIONS FOR OPERATION

Presetting and Recording of Time Code (Cont'd)

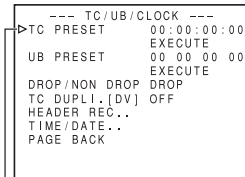

Time code (hour, min, sec, frame)

■ Presetting time cord data

The time code and user's bit data are preset on the TC/UB/CLOCK menu screen.

1. Display the TC/UB/CLOCK menu screen. Select the TC/UB/CLOCK item on the TOP MENU screen.
2. Set the time code (hours, minutes, seconds, frames).
 - ① Rotate the SHUTTER dial to align the cursor (▶) with TC PRESET, and then press the SHUTTER dial.
 - The first digit of the time code blinks. The blinking digit is the one to be set.
 - ② When the SHUTTER dial is pressed, the blinking digit changes.
 - ③ When the SHUTTER dial is rotated, the value of the blinking digit changes. When the SHUTTER dial is rotated upward, the value becomes higher. When rotated downward, the value becomes smaller.
 - ④ Repeat the procedure described in ② and ③ above to set the desired value for all digits.
 - ⑤ After setting the frame digit, press the SHUTTER dial to make EXECUTE blink. The setting values are confirmed when the SHUTTER dial is pressed again. To cancel the setting, select CANCEL and press the SHUTTER dial.
3. When all the digits are set
 - Press the STATUS button to return to the normal screen or
 - Rotate the SHUTTER dial to align the cursor (▶) with the PAGE BACK item, and then press the SHUTTER dial to return to the TOP MENU screen.

■ Presetting user's bit data

The user's bit data are preset with the UB PRESET item on the TC/UB/CLOCK menu screen.

The method for setting is the same as the method for setting the time code described above.

- The user's bit can be specified using numerals or alphabetic letters from 0 to F for each digit.
- To record user's bit data, set the UB REC item to ON.

CAUTION

It is not possible to set all the digits of the user's bit data to "F".

Reading of the data during playback will not be possible for an all-F setting.

■ Zero-resetting the Time Code or User's Bit Data

This is performed with the TC or UB PRESET item on the TC/UB/CLOCK menu screen. (Performed separately for the time code and the user's bit data.)

- ① Rotate the SHUTTER dial to align the cursor (▶) with the TC or UB PRESET item, and then press the SHUTTER dial.
- ② Rotate the SHUTTER dial to select ZERO PRESET as the setting value, and then press the SHUTTER dial.

MEMO

When a menu screen is not being displayed, you can zero reset the time code data by simultaneously holding down the USER2 button and the STOP button for about 1 second.

PREPARATIONS FOR OPERATION

Screen Adjustment

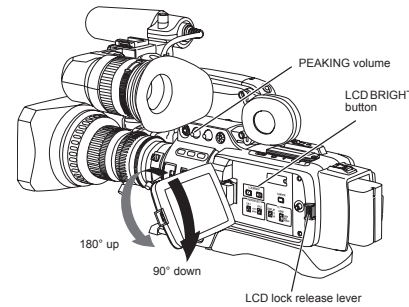

LCD monitor direction, angle, screen brightness, etc. can be adjusted.

■ Adjusting the Direction and Angle of the LCD monitor

- With the LCD door in the open condition, rotate the LCD door.
- It can be turned 180° in upward direction and 90° in downward direction. When turned 180° upward direction, the LCD monitor can be viewed from the lens side (vertically inverted image).

■ Adjusting the LCD monitor

- PEAKING: Adjusts the contour of the LCD monitor.
- LCD BRIGHT: Adjusts the brightness of the LCD monitor.

Adjustments are made on the LCD/VF [3/3] menu screen.

☞ See page 73.

- LCD CONTRAST: Adjusts the contrast of the LCD monitor.

Viewfinder Adjustment

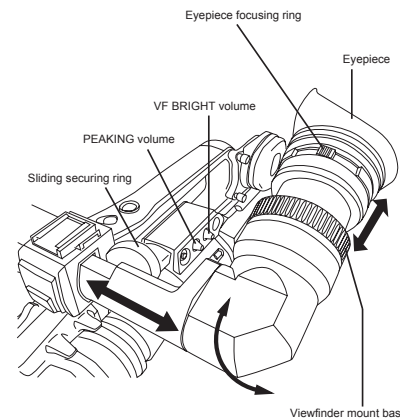

■ Direction of the Viewfinder

Adjust the position and angle of the viewfinder.

■ Diopter Adjustment

Rotate the eyepiece focusing ring until the viewfinder screen image is clearly visible.

■ Adjustment of the Viewfinder Screen

- PEAKING: Adjusts the contour of the LCD monitor and the viewfinder screen.
- VF BRIGHT: Adjusts the brightness of the viewfinder screen.

Adjustments are made on the LCD/VF [3/3] menu screen.

☞ See page 73.

- VF CONTRAST: Adjusts the contrast of the viewfinder screen.

MEMO

The screen size of the viewfinder can be changed by selecting the desired size with the ASPECT item on the VIDEO FORMAT menu screen (4:3 or 16:9).

Back Focus Adjustment

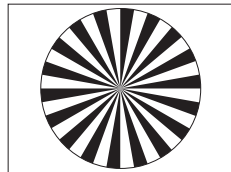
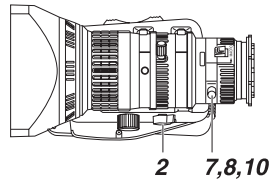
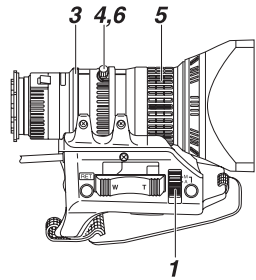

Siemens star chart

It is only necessary to perform this when the lens is attached for the first time or when focusing is not correct in both the telephoto and wide-angle positions.

- It is easier to adjust back focus when the subject is more than 3 meters from the camera.
The optimal subject for this adjustment is a Siemens star chart.

- Set the IRIS mode switch to M (Manual).
- Set the zoom mode to M (Manual).
- Open the iris by turning the iris ring.
If the illumination is too strong, reduce it or move to a darker place.
- Turn the zoom lever until the lens is at the maximum telephoto position.
- Bring the subject into focus.
- Set the lens to maximum wide-angle.
- Loosen the back focus ring retaining knob.
- View the same subject and adjust the back focus ring for the best possible focus.
- Repeat steps 4. through 8. about three times for fine adjustment until the subject remains in focus in both the telephoto position and the wide-angle position.
- Tighten the back focus ring retaining knob to secure the ring.

White Balance Adjustment

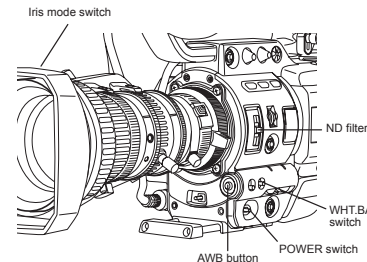

Since the color of light (color temperature) varies depending on the light source, it is necessary to re-adjust the white balance when the main light source illuminating the subject changes.

White Balance Adjustment

Two kinds of white balance adjustment results can be stored in memories AUTO A and AUTO B.

Adjustment procedure

- Set the following switches.
 - Set the POWER switch to ON.
 - Set the IRIS mode switch of the lens to A (Auto).
 - Set the FULL AUTO switch to OFF.
- Set the ND filter switch according to the current lighting.
- Set the WHT.BAL switch to A or B.
- Place a white object near the center of the screen under the same lighting conditions as the target subject and zoom in to fill the screen with white.
- Press the AWB (Auto White Balance) button.
"AUTO WHITE A, B OPERATION" is displayed in the viewfinder while the auto white balance adjustment circuit operates.
When correct white balance is obtained, the approximate color temperature is displayed together with "AUTO WHITE A, B OK" for about 5 seconds.

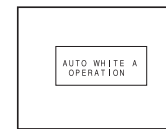

During operation



Result message



Improper object



Insufficient illumination



Excessive illumination

Error messages

If the adjustment ends abnormally, an error message, as described below, blinks for about 5 seconds.

- NG: OBJECT (Improper object)
Displayed when there is not enough white color on an object or the color temperature is not suitable.
Replace the color temperature conversion filter or use another white object and re-adjust the white balance.
- ERROR: LOW LIGHT (Insufficient illumination)
Displayed when the illumination is dim. Increase the illumination and then re-adjust the white balance.
- ERROR: OVER LIGHT (Excessive illumination)
Displayed when the light is excessively bright. Decrease the illumination and then re-adjust the white balance.

Full Auto White Balance (FAW)

The FAW function adjusts the white balance value automatically as the lighting condition changes.

This mode is convenient when you have no time to adjust the white balance or when the camera is moved frequently in and out of places under different lighting conditions.

Setting procedure

The FAW function can be activated with the FAW item on the SWITCH MODE menu screen. The FAW function can be allocated to one of the white balance switching switches A, B, or PRESET.
See page 69.

CAUTION

- Do not adjust using any highly reflective objects, such as metal, etc., as this may result in improper white balance adjustment.
- The FAW (Full Auto White balance) function cannot provide optimum white balance with a subject outside the FAW adjustment range, for example when it contains only a single color or not enough white color.
- The accuracy of the FAW (Full Auto White balance) is inferior to that of the Auto white balance.
- When the power is turned on with the FAW mode selected, it takes about 10 seconds for the FAW adjustment to be completed.
Do not shoot within this interval.

SETTING AND ADJUSTMENTS BEFORE SHOOTING

Setting the Video Format

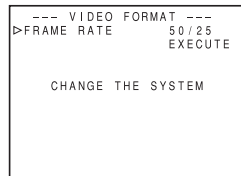
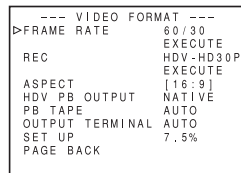
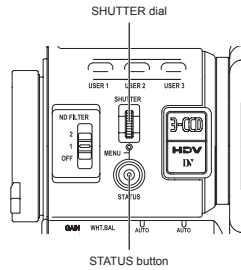

Set the video format using the FRAME RATE item and the REC item on the VIDEO FORMAT menu screen.

Setting the FRAME RATE Item

1. Press the STATUS button for at least 1 second.
 - The TOP MENU screen is displayed.
2. Turn the SHUTTER dial and bring the cursor (▶) to the VIDEO FORMAT.. item and press the SHUTTER dial.
 - The VIDEO FORMAT menu screen is displayed.
3. Turn the SHUTTER dial and bring the cursor (▶) to the FRAME RATE item and press the SHUTTER dial.
 - The setting for the selected item flashes and can be changed.
 - "CHANGE THE SYSTEM" is displayed on the screen.
4. Turn the SHUTTER dial, change the setting and push the SHUTTER dial.
 - The setting stops flashing and is temporarily set.
 - Move the cursor (▶) to the EXECUTE item and EXECUTE flashes.
5. Push the SHUTTER dial.
 - "REBOOT! SYSTEM CHANGE" is displayed on the screen and after a few seconds the system is rebooted.

Setting the REC Item

Set the REC item using the same steps as for the FRAME RATE item.

MEMO

- If you change the FRAME RATE item setting, the system is rebooted.
- The synchronous video signal is momentarily disturbed when the REC item setting is switched.

About the Motion Smooth Function

When you set the MOTION SMOOTH item on the CAMERA PROCESS [2/2] menu screen to ON with the REC item set to HDV-HD30P, HDV-HD25P or HDV-HD24P, the video can be played back more smoothly than with normal progressive video. See page 66.

SETTING AND ADJUSTMENTS BEFORE SHOOTING

Camera Settings

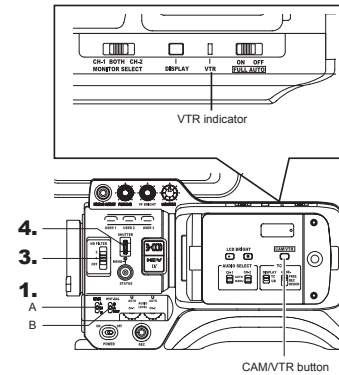

1. Set the switch positions.
 - A. [GAIN] switch: Set to L (0 dB).
 - B. [WHT. BAL] (Auto White Balance) switch: Set to A or B.
2. Set the lens' iris mode switch to "A" (Auto iris side).
3. Select the ND filter.

ND FILTER	Suitable Location
OFF	Indoors, dark outdoors
1	Outdoors under clear sky
2	Outdoors under extremely clear sky

4. Set the shutter speed to OFF with the SHUTTER dial.

Screen Size (4:3/16:9) Mode Selection

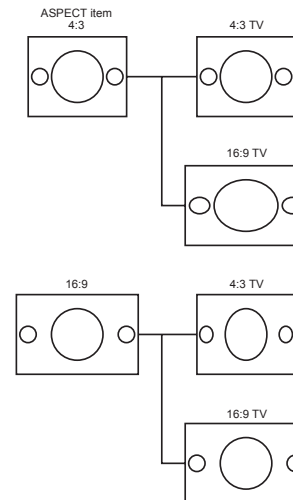

The screen size of recorded images can be selected with the ASPECT item on the VIDEO FORMAT menu screen. See page 62.

- To record using the standard screen, set ASPECT to 4:3.
- To record using the 16:9 screen, set ASPECT to 16:9.

MEMO

- When you set the REC item on the VIDEO FORMAT menu to HDV format, the ASPECT item is fixed at 16:9 and "[16:9]" is displayed.
- In the SAFETY_ZONE item on the LCD/VF [1/3] menu screen, you can display the safety zone for a standard screen as well as a 16:9 screen in the viewfinder or LCD monitor. See page 71.
- When the ASPECT item is set to 4:3, the screen that is displayed may differ depending on the 16:9 television you are using.

Audio Input Signal Selection

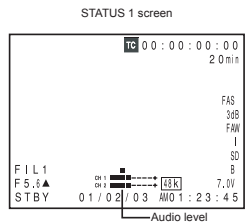
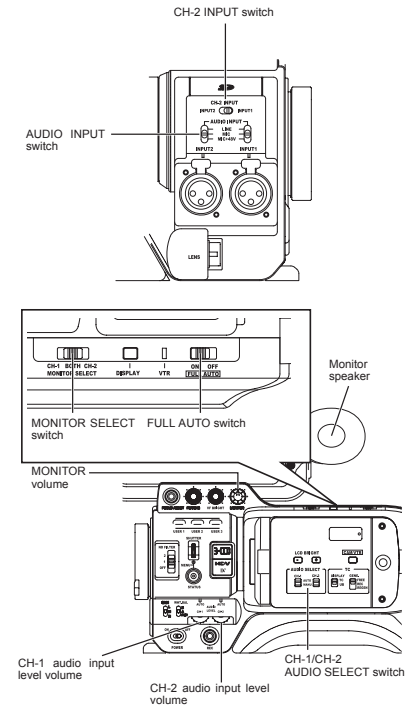

Indicator level (reference)

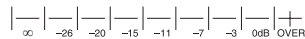

The GY-HD100 is provided with the INPUT1 connector and the INPUT2 connector for audio input. Select the audio from the INPUT1 connector or the INPUT2 connector using the CH-2 INPUT switch for the audio to be recorded in CH-2.

■ Selecting the CH-2 channel input connector

Select using the CH-2 INPUT switch.

INPUT1 : Inputs the audio from the INPUT1 connector into CH-2.

INPUT2 : Inputs the audio from the INPUT2 connector into CH-2.

MEMO

The audio from the INPUT1 connector is also input into CH-1 regardless of the setting.

■ Selecting the audio signal input

Select the sound to be input to the INPUT1 or INPUT2 connector using the AUDIO INPUT switch.

The setting is made for each of INPUT1 or INPUT2 connector.

LINE : Set to this position when connected to audio equipment, etc. The reference input level is +4 dBs.

MIC : Set to this position when using a dynamic microphone.

MIC+48V : Set to this position when a microphone (phantom microphone) requiring +48 V DC power supply is connected.

CAUTION

When connecting a component that does not require +48 V power supply, make sure that the switch is not set to MIC+48V before the component is connected.

MEMO

You can select the normal input level for MIC and MIC+48V in the INPUT1, 2 MIC REF. item on the AUDIO/MIC menu screen.

■ Adjusting Audio during Recording

For each audio channel, use the CH-1/CH-2 AUDIO SELECT switch to select whether the audio level adjustment should be set to AUTO mode or MANUAL mode.

■ Adjusting the audio input level control

The audio input level can be adjusted manually when the GY-HD100 is in the record, record-standby or stop mode.

1. Set the CH-1/CH-2 AUDIO SELECT switch of the channel whose audio level that you want to adjust manually to MANUAL.

2. Rotate the audio input level control corresponding to the audio input level to be adjusted.

- Adjust so that the peak level does not exceed the -3 dB point when a loud sound is input.

CAUTION

- When the AUDIO INPUT switch is set to MIC, be sure to check that the microphone is connected to the INPUT1/2 connector. If the microphone is not connected, increasing the audio level could cause noise from the input connector to be recorded on the tape. When the microphone is not connected to the INPUT1/2 connector, set the AUDIO INPUT switch to "LINE" or turn down the audio level control.
- In the FULL AUTO mode, the audio level volume cannot be adjusted with the audio level controls on the CH-1 and CH-2.

MEMO

The reference level for audio recorded on the tape can be set with the AUDIO REF. LEVEL item on the AUDIO/MIC menu screen. (-20 dB or -12 dB) The level will change for both CH-1 and CH-2.

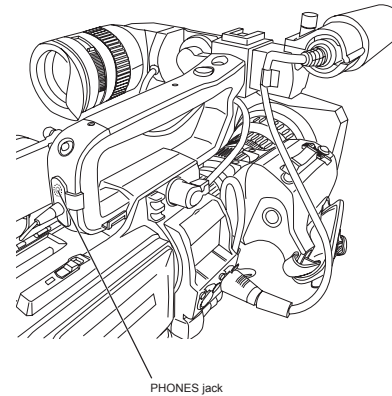

■ Monitoring Audio during Recording

The audio input during recording, in record-pause or stop mode can be monitored through the monitoring speaker or earphone.

Select the audio channel to be monitored using the MONITOR SELECT switch.

CH-1 : The sound input to the CH-1 channel is output.
BOTH : The sound input to the CH-1 and CH-2 channels is output mixed.

CH-2 : The sound input to the CH-2 channel is output.

The MONITOR volume control adjusts the monitoring volume.

The loudspeaker or earphone outputs an alarm tone in the case of an abnormal condition occurring in the unit.

An alarm tone is also output when the tape end is reached or when the battery is running down.

- Do not increase the audio monitoring volume excessively; otherwise howling with the camera microphone may occur.

MEMO

When connecting a stereotype earphone, make the following settings to output stereo sound.

- Set the MONITOR SELECT switch to BOTH.
- Set the AUDIO MONITOR item on the AUDIO/MIC menu screen to STEREO.

When AUDIO MONITOR item on the AUDIO/MIC menu screen is set to "STEREO", only the audio of CH-1 is output from the monitoring speaker.

The volume of the alarm tone is set with the ALARM VR LEVEL item on the OTHERS [1/2] menu screen. (OFF/LOW/MIDDLE/HIGH)

SHOOTING OPERATION

Basic Recording Operation

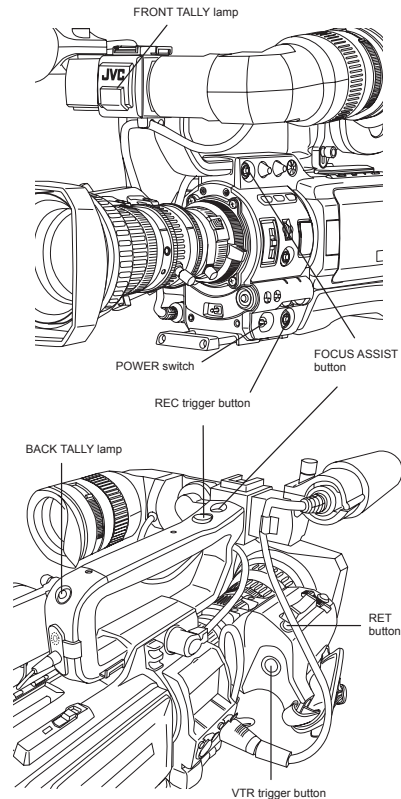

About the QUICK REC START Mode

If the REC/VTR trigger button is pressed immediately after the videocassette is inserted, the mode becomes the QUICK REC START mode that enables quick start of recording.

However, when shooting starts in the middle of the tape, a blank space appears as the new scene will not be linked smoothly with the previous image.

Also, the time code does not continue. (Some overlap may also occur.)

1. Set the POWER switch to ON.
 - The unit turns on in camera mode.
2. Start recording.

Press the REC/VTR trigger button on the GY-HD100 to start recording.

Once recording has started, the FRONT TALLY lamp and BACK TALLY lamp light red.

MEMO

The way the FRONT TALLY and the BACK TALLY lamps flash differ depending on what you set in the FRONT TALLY and BACK TALLY items on the OTHERS [1/2] menu screen.

☞ See page 77.

CAUTION

- The unit enters the stop mode automatically at TAPE END. If this mode continues for 3 minutes, the mode switches to the tape protect mode.
 - ☞ See "OTHERS [1/2] Menu Screen" on page 77. (LONG PAUSE TIME item)
- If the REC/VTR trigger button is pressed very quickly and repeatedly, or the POWER switch is moved immediately after the trigger button is pressed, the GY-HD100 may not enter the record mode.

To remedy this condition set the POWER switch to OFF and wait for 5 seconds or more before turning the power on again.
- A neat transition to the next recorded scene cannot be guaranteed if a recording is ended by turning the POWER switch or DC power supply OFF, or by removing the battery pack.
- Trial-shooting is always recommended before recording important events to confirm the recording is satisfactory.
- The microphone may pick up the sound of the lens' iris if the iris is changed abruptly or the iris is manually moved abruptly during recording.

■ About the Focus Assist Function

When you press this button during shooting, the area of focus is displayed in blue, red or green, making it easy to focus accurately.

- ☞ See "LCD/VF [1/3] Menu Screen" on page 71. You can also set this function from the RET button.
- ☞ See "SWITCH MODE Menu Screen" on page 69. (LENS RET item)

SHOOTING OPERATION

■ Checking Recorded Contents in Record-Standby Mode (Recording Check Function)

This function is available only when the GY-HD100 is in the standby mode.

In standby mode, about 5 seconds of the last part of the content recorded in DV format can be played back, and about 7 seconds when the content was recorded in HDV format can be played back.

- The recorded contents can be checked on the LCD monitor, in the viewfinder or on a monitor connected to the video signal output connectors.
- The video image from the VTR section is shown on the LCD monitor, in the viewfinder or on the monitor connected to the video signal output connectors.

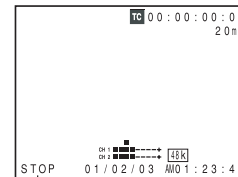

VTR mode indication

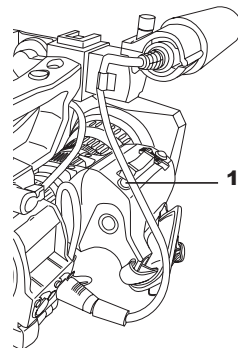

1. RET button

1. In the record-standby mode, press the RET button on the camera lens section.
 - The tape rewinds and about 6 seconds of the content recorded in DV format is played back, and about 8 seconds of the content recorded in HDV format is played back. After playback, the camcorder returns to standby mode at the position on the tape where the RET button was pressed.
- If you continue to hold down the RET button, up to about 18 seconds of content recorded in DV format and up to about 20 seconds of content recorded in HDV format can be rewound and played back.
 - Pressing the REC/VTR trigger button during playback will put the unit in REC standby mode. The camera will automatically return to recording mode after playback.

CAUTION

- This function does not work when using RET button is used as FOCUS ASSIST button.
- This function does not work when the GY-HD100 is in the stop mode.
- During recording check, the following indication will appear if the error rate increases due to head clogging, etc. "HEAD CLEANING REQUIRED!" is shown on the LCD monitor or in the viewfinder. (When the STATUS 0, 1, 4 screen is displayed.)

■ If the Record-Standby Mode Continues

Setting the time before the tape protection mode is engaged

The time before the tape protection mode is engaged from the record-standby mode can be set to 5 minutes or 3 minutes with the LONG PAUSE TIME item on the OTHERS [1/2] screen menu. ☞ See page 77.

When the record-standby mode has continued for about 5 minutes or 3 minutes, the GY-HD100 automatically stops drum rotation in order to protect the tape. (Tape protect mode)

In the tape protect mode, STOP is shown as the VTR mode indication on the LCD monitor and in the viewfinder screen. (STATUS 1 screen)

- To start recording from the tape protect mode, press the REC/VTR trigger button.
 - The drum starts rotating, and recording starts after about 3 seconds.
- To return to the record-standby mode from the tape protect mode, press the RET button.

CAUTION

This function does not work when using RET button is used as FOCUS ASSIST button.

HEADER REC Function

When the REC/VTR trigger button is pressed while the STOP button is pressed, this function first records the color bar video and the test tone (1 kHz sine-wave) of the built-in signal generator at the beginning of the tape. Then it records the black video signal and the mute audio signal for the duration specified in advance. When the recording is completed, the unit enters the Record-Standby mode. The time code value at the Record-Standby position becomes the time code specified in advance. (HEADER REC function)

- Settings related to the HEADER REC function, such as whether the HEADER REC function should be enabled, the HEADER REC execution duration, and the time code value setting when the HEADER REC recording is completed, etc., are made on the HEADER REC menu screen.
- The HEADER REC function is executed under the following circumstances:
CAM/VTR button: Set to CAM mode.
In the Record-Standby or Stop mode

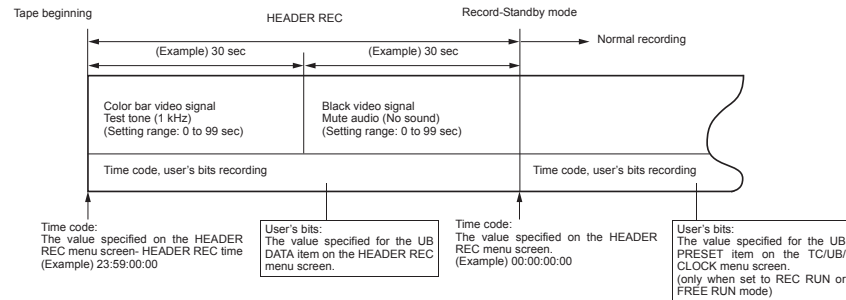

■ HEADER REC menu screen contents

Item	Function/Initial Setting
START KEY	Sets whether the HEADER REC operation should be executed when the REC/VTR trigger button is pressed while the STOP button is pressed. DISABLE : HEADER REC operation is not executed. STOP+REC : HEADER REC operation is executed.
TC DATA	Sets the time code value for the point when the Record-Standby mode is engaged following completion of HEADER REC. EXECUTE : Confirms the set time code. ZERO PRESET: Resets all time codes to zero "0". CANCEL : Clears the set time code. The frame mode is set depending on the setting in the DROP/NON DROP item on the TC/UB/CLOCK menu screen. * The time code value at the point when the Record-Standby mode is engaged may differ some frames from the value set for this item.
UB DATA	Sets the user's bits of the HEADER REC section. EXECUTE : Confirms the set user's bits. ZERO PRESET: Resets all user's bits data to zero "0". CANCEL : Clears the set user's bits. MEMO The user's bits for the normal recording section are set on the TC/UB/CLOCK menu screen.
BARS TIME	Sets the duration (seconds) in which the color bar signal and test tone (1 kHz) is recorded during HEADER REC. (1-sec steps) [Initial Setting: 0SEC - 30SEC - 99SEC]
BLACK TIME	Sets the duration (seconds) in which the black signal is recorded during HEADER REC. (1-sec steps) [Initial Setting: 0SEC - 30SEC - 99SEC]
PAGE BACK	The TC/UB/CLOCK menu screen returns when the SHUTTER dial is pressed.

2. Setting the HEADER REC menu screen.

- ① Select the menu item.
Rotate the SHUTTER dial to align the cursor (▶) with the item to be set, and then press the SHUTTER dial.
• The setting area of the selected item starts blinking.
- ② Changing the setting value.
Rotate the SHUTTER dial to change the setting, and then press the SHUTTER dial.
■ In the case of the TC DATA item and the UB DATA item, the blinking digit position moves when the SHUTTER dial is pressed. When the SHUTTER dial is rotated, the value of the blinking digit changes. After all the digits have been set and the SHUTTER dial is pressed, EXECUTE starts blinking. Press the SHUTTER dial once more to confirm the set value.

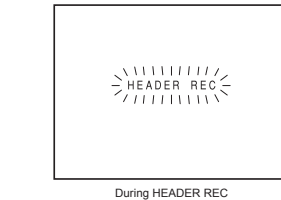
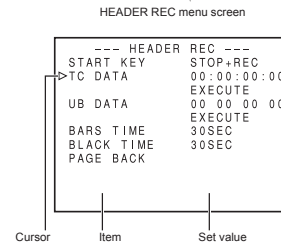
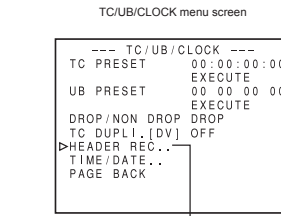

- The menu screen is not displayed during HEADER REC recording.

■ How to set the HEADER REC menu screen

1. Display the HEADER REC menu screen.
 - ① Select the TC/UB/CLOCK.. item on the TOP MENU screen.
 - ② Select the HEADER REC item on the TC/UB/CLOCK menu screen.

3. To terminate the setting, press the STATUS button.

■ Executing the HEADER REC Function

The START KEY item on the HEADER REC menu screen should be set to STOP+REC.

1. Load the cassette and engage the Record-Standby mode or the Stop mode.
2. While pressing the STOP button, press the REC/VTR trigger button.
 - The tape automatically rewinds to the beginning, and HEADER REC operation starts from the beginning of the tape.
 - After HEADER REC recording is performed for the specified duration only, the Record-Standby mode is engaged automatically.
 - During HEADER REC recording, "HEADER REC" is shown (blinking) on the LCD monitor and in the viewfinder.
3. After HEADER REC recording is completed and the Record-Standby mode is engaged, normal recording starts when you press the REC/VTR trigger button.
 - When the TC GENE. switch is set to either REC or REGEN, the time code value at the start of the HEADER REC menu screen.

MEMO

- To stop during HEADER REC operation, press the REC/VTR trigger button or the Stop button.
- The HEADER REC menu screen cannot be opened during HEADER REC recording.
- HEADER REC operation is accepted even during loading of the cassette tape.
- The test tone (1 kHz sine-wave) recorded in the color bar section will be recorded unrelated to the setting for the TEST TONE item on the AUDIO/MIC menu screen.
- The time code preset on the TC/UB/CLOCK menu screen becomes invalid when HEADER REC recording is performed.
- The user's bits following completion of HEADER REC recording will be the user's bits value set on the TC/UB/CLOCK menu screen.
- The running of the time code following completion of HEADER REC recording will be in accordance with the setting of the TC GENE. switch.
FREE RUN: Continuous running.
REC RUN or REGEN: Runs only during REC.
- Camera images are not output to the LCD monitor, viewfinder or video output during REW mode when the HEADER REC operation begins.

PLAYBACK MODE

Playback Procedure

Recorded pictures can be viewed in the viewfinder, or on the LCD monitor, or on the monitor connected to the video output connector.

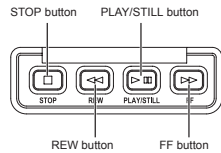

MEMO

The GY-HD100 can play back the following two types of videocassettes:

- MiniDV videocassette
- DVCAM videocassette
- Tapes recorded in the LP mode cannot be played back.

1. Set the POWER switch to ON.
2. Set the unit to the VTR mode.
Press the CAM/VTR button to turn on the VTR indicator.
* Playback is also possible in the Camera mode.
Playback operation becomes possible when the STOP button is pressed to set the VTR operation mode indicator to indicate STOP.
3. Load the recorded videocassette correctly.
 - When the videocassette is loaded, the unit enters the Stop mode.
4. Open the operation cover on the upper section of the unit.
Slide the operation cover to the side to open.
5. Press the PLAY/STILL button.
 - Playback starts.
6. Press the PLAY/STILL button to stop playback temporarily.
 - The unit enters the still mode.
7. To re-start playback, press the PLAY/STILL button.
8. To stop playback or the still mode, press the STOP button.

MEMO

- In the VTR mode, the camera image is not output on the LCD monitor, in the viewfinder or through the video output connector.
- When the still picture mode or stop mode has continued for a while, the unit automatically switches to the tape protect mode.
Tape protect mode : Drum rotation is stopped in order to protect the tape.
- Noise may appear in the picture in the still mode.
- When the automatic tracking function is activated at the start of the playback mode, digital noise may appear in the playback image.
- This unit does not allow manual tracking adjustment.
- When playing back a tape that was recorded on another unit, digital noise may appear during playback.

- Following loading of the tape, the built-in head cleaner will emit a sound while operating. This does not indicate a malfunction.
- The data recorded for the date and time or time code on the tape can be shown on the screen. To enable or disable the display is selected on the menu screen:
Display of date and time : TIME/DATE menu screen
Display of time code : LCD/VF [2/3] menu screen

Fast-Forward, Rewind

- Press the FF button in the stop mode to fast forward the tape. Press the REW button in the stop mode to rewind the tape.
(VTR mode only)
 - * "SWITCH TO VTR MODE" is displayed and the function does not work if the "FF" or "REW" buttons are pressed when Camera mode is in the stop mode.
 - Press the STOP button to stop fast forwarding or rewinding.
- MEMO**
- When the tape approaches the end during fast forwarding or rewinding, the tape speed decelerates to protect the tape.
 - The time required for fast forwarding and rewinding may become longer when used in a cold environment. This is not a malfunction.

Search

- Press the FF button in the play mode or still mode to search the tape in the forward direction. Playback takes place while fast forwarding.
Pressing the REW button executes search of the tape in the reverse direction. Playback takes place while rewinding.
(Each press on the button switches the speed to ×2, ×5, and ×10.)
- Press the PLAY/STILL button to resume normal playback.
- Press the STOP button to stop.

MEMO

- To output sound during the search, set the SEARCH AUDIO [DV] item on the AUDIO menu screen to ON.
- Block noise may appear in the picture or the image may freeze during the search.

PLAYBACK MODE

Outputting Audio

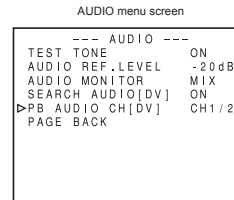
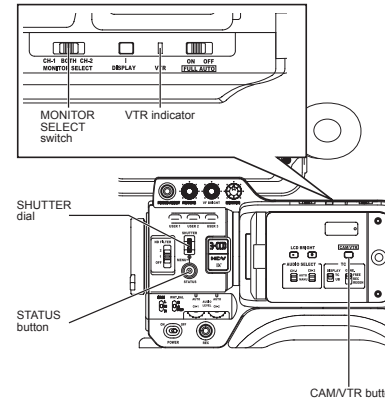

Setting

Confirm that the GY-HD100 is in the VTR mode. (VTR indicator: On)

1. Display the AUDIO menu screen.
Select the AUDIO item on the TOP MENU screen.
2. Set the AUDIO menu screen.
 - AUDIO MONITOR Items
 - MIX : Outputs mixed audio
 - STEREO : Outputs stereo audio
 - PB AUDIO CH [DV] Items
 - CH1/2 : To reproduce the sound (CH-1, CH-2) recorded during shooting.
 - MIX : To reproduce the sound recorded during shooting (CH-1, CH-2) and the after-recorded sound (on CH-3 and CH-4) simultaneously.
 - CH3/4 : To reproduce the sound after-recorded on CH-3 and CH-4.
3. Set the MONITOR SELECT switch.
Refer to Table 1 below to make the setting.
4. Either of the following operations returns you to the normal screen.
 - Press the STATUS button or
 - Return to the TOP MENU screen, select the EXIT item and press the SHUTTER dial.

MEMO

The DV format is capable of recording up to 4 channels when the 12-bit, 32 kHz sampling frequency is employed. The GY-HD100 records audio on the two channels CH-1 and CH-2. (4-channel recording is possible in the case of DV input. (GY-HD100U/GY-HD101E only))
When the GY-HD100 is used for playback of a tape that was recorded on another unit with audio recorded on the CH-3 and CH-4 channels, the PB AUDIO CH [DV] item on the AUDIO menu screen must be set.
After-recording on the CH-3 and CH-4 channels is not possible.

Table 1

* In HDV format, you can only select the settings within the bold frame.

MONITOR SELECT	PB AUDIO CH [DV]			
	AUDIO MONITOR	CH1/2	MIX	CH3/4
CH-1	-	L/R:CH1	L/R:CH1+CH3	L/R:CH3
BOTH	MIX STEREO	L/R:CH1+CH2 L:CH1 R:CH2	L/R:CH1+CH2+CH3+CH4 L:CH1+CH3 R:CH2+CH4	L/R:CH3+CH4 L:CH3 R:CH4
CH-2	-	L/R:CH2	L/R:CH2+CH4	L/R:CH4

USING EXTERNAL COMPONENTS

Connecting the Video Signal Cables

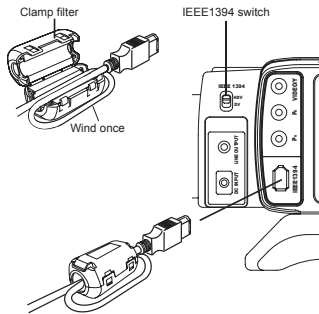

■ Connecting the IEEE1394 Cable

To reduce the emission of unwanted radio waves, be sure to attach the provided clamp filter as shown in the figure on the left.

- Attach the clamp filter as close to the camcorder as possible, as shown in the figure.
- Set the IEEE1394 switch on the left panel of the camcorder.
 - DV : DV format
 - HDV : HDV format

CAUTION

Connect the cables and set the switches with the power on the device OFF.

■ Composite and Component Connections

The video signals output from the video signal output connectors on this camcorder (VIDEO/Y, Pb, Pr) are as described below, depending on the settings for the OUTPUT TERMINAL item on the VIDEO FORMAT menu screen.

- AUTO : Automatically switches to a composite or component signal, depending on which cable is connected to the video signal output terminal and outputs the signal.
- COMPOSITE : Outputs a composite signal regardless of which cable is connected to the video signal output connector.
- COMPONENT : Outputs a component signal regardless of which cable is connected to the video signal output connector.

Output signal when AUTO is set

Connector (○: Unconnected ●: Connected)			Output Signal
VIDEO/Y	Pb	Pr	
●	●	●	COMPONENT
●	○	●	COMPOSITE
●	●	○	COMPONENT
●	○	○	COMPOSITE
None of the above			OFF

In addition, you can use the PB TAPE item to set whether to automatically detect the video format of the playback tape or only play back a particular format when playing back a tape. See page 63.

CAUTION

Be careful not to apply excess force to the video signal output terminal when connecting or disconnecting the cable. This will cause poor contact or failure.

■ Displaying Alarms

- CHANGE 1394 SWITCH
Displayed when the setting for the input/output video format from the IEEE1394 connector and the setting for the IEEE1394 switch are different.
Set the IEEE1394 switch so it matches the video format.

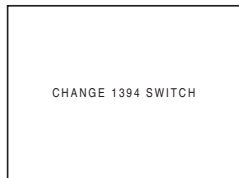
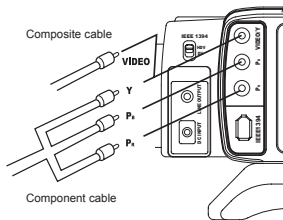

USING EXTERNAL COMPONENTS

Dubbing with AV Devices

1. Composite cable or Component cable

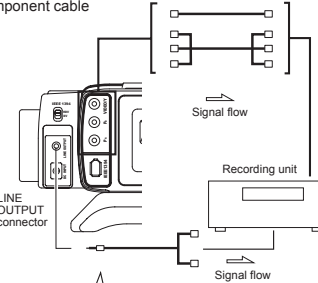

1. Audio cable

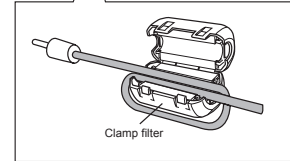

By connecting the video signal output terminal and the LINE OUTPUT terminal on this camcorder to an AV device, analog signal dubbing is possible.

1. Connect the cables.

Use the provided cable for the audio cable. To reduce the emission of unwanted radio waves, be sure to attach the provided clamp filter as shown in the figure on the left.

- Attach the clamp filter as close to the camcorder as possible, as shown in the figure.

2. Turn both devices on.
3. Set the camcorder to VTR mode. Press the CAM/VTR button. The VTR indicator lights.

4. Set the video output.
 - Set the VIDEO FORMAT menu screen. See page 62.
 - HDV PB OUTPUT item: Set the video format to be output from the video output terminal during tape playback.
 - PB TAPE item: Select whether to automatically detect the playback tape video format or play back only a particular format. Normally, use the "AUTO" setting.
 - OUTPUT TERMINAL item: Set either component or composite output. Normally, use the "AUTO" setting.

5. Set the audio output. See page 53.
 - Set the AUDIO/MIC menu screen. See page 70.
 - AUDIO MONITOR item: Set stereo audio or mixed audio.
 - PB AUDIO CH [DV] item: Set the audio channel to be output.
 - Set the MONITOR SELECT switch.

6. Insert the videocassettes.
 - GY-HD100 : Insert the recorded videocassette.
 - Recording unit : Insert the videocassette to be dubbed to.

7. Press the PLAY/STILL button on the GY-HD100 to start playback.

8. Start recording on the recording unit. For details, see the instructions to the unit used for recording.

9. When dubbing is completed. Stop recording on the recording unit, and then press the STOP button on the GY-HD100 to stop playback.

- 4.

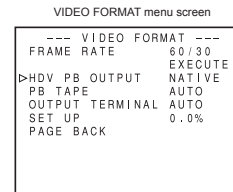

- 5.

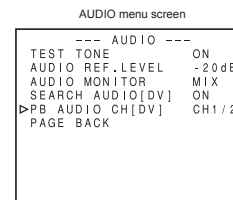

USING EXTERNAL COMPONENTS

HDV/DV Dubbing

1.

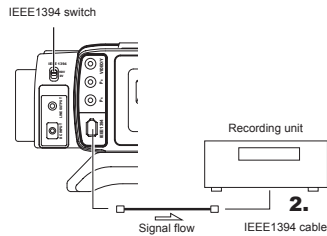

CAUTION

- Set the IEEE1394 switch on both devices to either HDV or DV.
- Start recording after making sure that both devices are properly connected.

5.

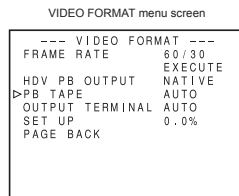

Connecting the GY-HD100 to another video component equipped with HDV/DV connector (IEEE1394 standard) using a IEEE1394 cable (optional) enables dubbing of digital signals with high picture quality and high-quality sound.

■ Using the GY-HD100 as the playback unit (Dubbing to another video)

1. Set the IEEE1394 switch on the left panel of the camcorder.
 - DV : When dubbing in DV format
 - HDV : When dubbing in HDV format
2. Connect the IEEE1394 cable.
3. Turn both devices on.
4. Set the camcorder to VTR mode. Press the CAM/VTR button. The VTR indicator lights.
5. Set the PB TAPE item on the VIDEO FORMAT menu screen.
 - See page 63.
 - Select whether to automatically detect the playback tape video format or play back only a particular format. Normally, use the "AUTO" setting.
6. Insert a videocassette tape.
 - This camcorder : Recorded videocassette tape
 - Recording unit : Videocassette you want to dub
7. Press the PLAY/STILL button on this camcorder to start playback.
8. Start recording on the recording device. See the recording device user manual for more information.
9. When dubbing is finished, stop recording on the recording device, press the STOP button on the camcorder, and stop the playback.

MEMO

- Switch the IEEE1394 switch when the camcorder is OFF.
- When you dub still images, they are low resolution images. Noise may also enter the audio.
- Operations may differ depending on the features and specifications of the connected device, and operations or data exchange may not be possible even if the devices are connected.
- If noise appears on the screen or the audio cuts out, re-connect the IEEE1394 cable or turn the GY-HD100 on again.
- If you turn the power to the device connected to the IEEE1394 connector on and off or switch the video input, noise may occur in the audio. If you perform this type of operation, set the speaker volume as low as possible on the audio device connected to the camcorder.
- Recording may not be possible in some cases even if the recorder is equipped with a IEEE1394 connector.

USING EXTERNAL COMPONENTS

1.

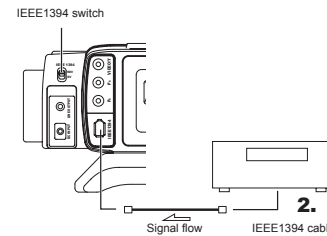

CAUTION

- Set the IEEE1394 switch on both devices to either HDV or DV.
- Start recording after making sure that both devices are properly connected.

6.

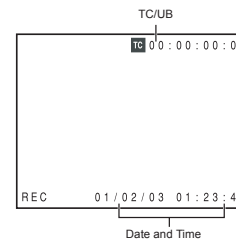
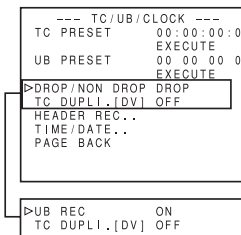

■ When Using the GY-HD100U/GY-HD101E as Recording Unit (Dubbing From Another Videocassette)

1. Set the IEEE1394 switch on left side of the GY-HD100.
 - DV : When dubbing in DV format
 - HDV : When dubbing in HDV format
2. Connect the units with the IEEE1394 cable.
3. Turn ON both units.
4. Place the GY-HD100 in the VTR MODE. Press the CAM/VTR button to turn on the VTR indicator.
5. Set the frame rate. Set the FRAME RATE item (60/30, 50/25, 24) on the VIDEO FORMAT menu to match the HDV/DV signal frame rate input from the IEEE1394 connector.
 - See page 62.
6. Set the time code and user bit recording. Set the TC DUPL. [DV] item on the TC/UB/CLOCK menu screen. (Only for DV format)

OFF	: Records the TC/UB set in the camcorder.
ON	: Records the TC/UB for the IEEE1394 input.
Date and time data	: Records the data sent from the playback device.

MEMO

In HDV format, the TC/UB set in the camcorder is recorded regardless of the setting.

7. Insert the videocassettes.
 - GY-HD100 : Insert the videocassette to be dubbed to.
 - Playback unit : Insert the recorded videocassette.
8. Start playback on the playback unit. For details, see the instructions to the unit used for playback.
 - The playback picture from the playback unit appears on the GY-HD100's LCD monitor and viewfinder screen.
9. Press the REC/VTR trigger button on the GY-HD100 to start recording.
 - To temporarily pause the recording, press the REC or VTR trigger button.
 - To restart the recording, press the REC or VTR trigger button again.
10. When dubbing is completed. Press the REC/VTR trigger button or the STOP button on the GY-HD100 to stop recording, and then stop playback on the playback unit.

MEMO

Depending on the player, sound may not be heard momentarily from this unit when switching modes from STILL to PLAY.

USING EXTERNAL COMPONENTS

Backup Recording

1.

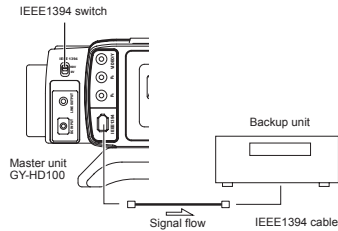

CAUTION

- Set the IEEE1394 switch on both devices to either HDV or DV.
- Start recording after making sure that both devices are properly connected.

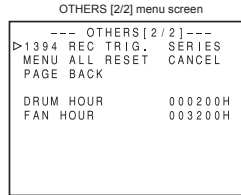

Backup Recording of the GY-HD100's Camera Image and Sound Through the IEEE1394 Connector

The GY-HD100's camera image and sound can be recorded for backup on another component that is equipped with IEEE1394 connector.

Connections

Use the GY-HD100 as the master unit.

Connect the master unit and the backup unit with a IEEE1394 cable.

Settings

1. Master unit (GY-HD100)

1. Set the IEEE1394 switch on left side of the GY-HD100.

- DV : When backup in DV format
- HDV : When backup in HDV format

2. Place in Camera mode.

3. Set the 1394 REC TRIGGER item on the OTHERS [2/2] menu screen. See page 78.

Backup unit

- Place in HDV/DV signal input mode.
- Depending on the used component, it may be necessary to set "REMOTE SELECT".
- When BR-HD50 is used, set the Backup Recording function to OFF.
- Insert the tape and set to STOP or REC PAUSE status.

Operation

Start and stop of recording on the backup unit takes place in accordance with the operation of the REC/VTR trigger button on the master unit.

(Depending on the GY-HD100 or the backup unit, the image, audio, and/or time code may deviate from what they should be at the points where the recording is started or stopped.)

MEMO

- When the backup recording is started, the "TRIGGER TO DV" or "TRIGGER TO HDV" indication is shown on the LCD or in the viewfinder for approx. 3 seconds.
- When the Series Recording function of BR-HD50 is used, the GY-HD100's 1394 REC TRIGGER item should be set to OFF.
- If the backup device is equipped with a feature to record time codes input from the IEEE1394 connector (TC DUPLICATE feature), time code data the same as on the master side can be recorded.
- When using BR-HD50 as a backup device and switching GY-HD100 from the playback mode to the record mode, noise will be noticed on the monitor output screen of BR-HD50 (backup will be correctly recorded).

MENU SCREENS

Menu Screen Configuration

The Menu Screen consists of multiple layers of menu screens as shown below. The menu screen to be set is selected from the TOP MENU in accordance with the function or purpose.

The items on the menu screens differ with the Camera mode and the VTR mode. The contents of set items are stored in the GY-HD100's memory and are retained even when the power is turned off.

The FILE MANAGE menu screen can be used to store the menu setting contents on the GY-HD100 or SD memory card.



Setting Menu Screens

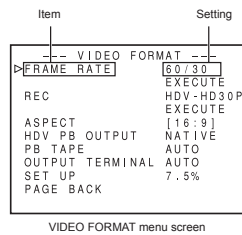
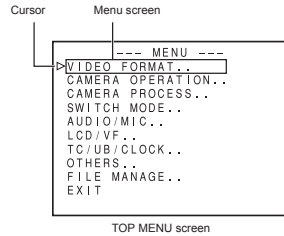
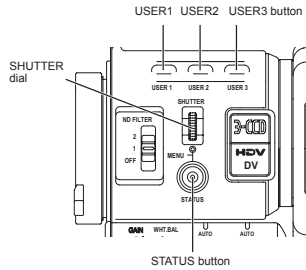

Make the settings while observing the LCD monitor or the viewfinder screen.

If the OUTPUT CHAR. item on the OTHERS [1/2] screen is set to ON, the menu screen can also be viewed on a monitor connected to the video signal output connector.

1. Set the POWER switch to ON.
2. Set the mode of the GY-HD100 with the CAM/VTR button. (Camera mode or VTR mode)
3. Press the STATUS button for 1 second or longer.
 - The TOP MENU screen appears.
4. Select the menu screen to be set. Rotate the SHUTTER dial to align the cursor (▶) with the menu screen to be set, and then press the SHUTTER dial.
 - The selected menu screen appears.
5. Select the menu item on the menu screen. Rotate the SHUTTER dial to align the cursor (▶) with the item to be set, and then press the SHUTTER dial.
 - The setting area of the selected item starts blinking, and the setting can now be made.
6. Change the setting. Rotate the SHUTTER dial to change the setting, and then press the SHUTTER dial.
 - The setting area stops blinking and the setting is entered.
 - To change multiple items, repeat the procedures in steps 5. and 6. above.
7. Return to the TOP MENU. Rotate the SHUTTER dial to align the cursor (▶) with the PAGE BACK item, and then press the SHUTTER dial.
 - To change settings on other menu screens, repeat the procedures in steps 4. to 7. above.
 - To save the set contents in FILE, select the FILE MANAGE menu screen and perform the operations for saving to file.
 - ☞ See "FILE MANAGE Menu Screen" on page 79.
8. To return to the normal screen after completing the settings, use either of the following methods. Press the STATUS button or Return to the TOP MENU screen and align the cursor (▶) with the EXIT item, and then press the SHUTTER dial.

MEMO

- While the menu screen is being displayed, the USER1, USER2 and USER3 buttons can also perform menu operations.
 - USER1 button: Raises the cursor (▶)/Changes the setting
 - USER2 button: Lowers the cursor (▶)/Changes the setting
 - USER3 button: Confirms the menu item/Confirms the setting
- The menu screen is not displayed when switching between Camera and VTR mode (VTR indicator flashes).

TOP MENU Screen

Different menu screens are displayed depending on whether the GY-HD100 is in the Camera mode or in the VTR mode. In the VTR mode, the CAMERA OPERATION, CAMERA PROCESS and SWITCH MODE menu screens are not displayed.

Item	Function
VIDEO FORMAT..	Displays the menu screen for setting the video format for shooting and playing back video. <ul style="list-style-type: none"> • The cursor (▶) does not move to this item when the camcorder is recording.
CAMERA OPERATION..	Displays a menu screen for setting the operation mode for camera shooting. <ul style="list-style-type: none"> • This item is only displayed in the Camera mode.
CAMERA PROCESS..	Displays a menu screen for adjustments of the picture quality of the camera image. It consists of two screens. The ADVANCED PROCESS menu screen and SKIN COLOR ADJUST screen can be displayed through the CAMERA PROCESS menu screen. <ul style="list-style-type: none"> • This item is only displayed in the Camera mode. • The cursor (▶) does not move to this item when the camcorder is in VTR mode (PLAY, STL, FWD, REV).
SWITCH MODE..	Displays the menu screens related to the camera switch functions. <ul style="list-style-type: none"> • This item is only displayed when in camera mode.
AUDIO/MIC..	Displays a menu screen related to audio. <ul style="list-style-type: none"> • In VTR mode, the screen changes to the AUDIO menu screen. • The cursor (▶) does not move to this item when the camcorder is recording.
LCD/VF..	Displays a menu screen for selecting whether to display characters on the LCD monitor or in the viewfinder, and for adjustments of the picture quality of LCD monitor. Camera mode: It consists of three screens. VTR mode: It consists of two screens.
TC/UB/CLOCK..	Displays a menu screen for setting the time code, user's bit data, date and time. The ways that the date and time are recorded together with the display style are set here. The TIME/DATE menu screen and CLOCK ADJUST screen can be displayed through the TC/UB/CLOCK menu screen. <ul style="list-style-type: none"> • The cursor (▶) does not move to this item when the camcorder is recording.
OTHERS..	Displays a menu screen for setting other functions and to display the hour meter. It consists of two screens.
FILE MANAGE..	Displays the FILE MANAGE menu screen. Saves the menu screen settings as a file on the camcorder or an SD memory card, or reads the menu screen settings saved in the file. It is also possible to reset the menu settings to default settings or initialize (format) an SD memory card. <ul style="list-style-type: none"> ☞ See "FILE MANAGE Menu Screen" on page 79. • The cursor (▶) does not move to this item when the camcorder is in VTR mode or is ejecting a tape.
EXIT	The normal screen returns when the SHUTTER dial is pressed while the cursor is aligned with this item.

VIDEO FORMAT Menu Screen

* This is not displayed in VTR mode.

Item	Function/Setting (bold characters indicate initial settings)																											
FRAME RATE	<p>Sets the frame rate for shooting.</p> <p>U model</p> <p>60/30 : Shoots at 480/60i, 480/60p, 720/30p. 50/25 : Shoots at 576/50p, 720/25p. 24 : Shoots at 480/24p (2:3:2:3 pulldown), 480/24p advance mode (2:3:3:2 pulldown), 720/24p.</p> <p>E model</p> <p>60/30 : Shoots at 480/60p, 720/30p. 50/25 : Shoots at 576/50i, 576/50p, 576/25p, 720/25p. 24 : Shoots at 720/24p. CANCEL : Cancels the settings. EXECUTE : Executes the settings.</p> <p>MEMO</p> <p>* If you change the FRAME RATE item setting, the system is rebooted. * See page 44. * The cursor (▶) does not move to this item when the camcorder is in VTR mode or is ejecting a tape.</p>																											
REC*	<p>Sets the video format for shooting. (Can only be displayed and set in camera mode) You can set the following according to the FRAME RATE.</p> <table border="1"> <thead> <tr> <th>Setting</th> <th>Description</th> <th>FRAME RATE</th> </tr> </thead> <tbody> <tr> <td>DV-60I</td> <td>DV format Shoots using a 480/60i signal. (U model Only)</td> <td rowspan="3">60/30</td> </tr> <tr> <td>HDV-SD60P</td> <td>HDV format Shoots using a 480/60p signal.</td> </tr> <tr> <td>HDV-HD30P</td> <td>HDV format Shoots using a 720/30p signal.</td> </tr> <tr> <td>HDV-SD50P</td> <td>HDV format Shoots using a 576/50p signal.</td> <td rowspan="3">50/25</td> </tr> <tr> <td>HDV-HD25P</td> <td>HDV format Shoots using a 720/25p signal.</td> </tr> <tr> <td>DV-50I</td> <td>DV format Shoots using a 576/50i signal. (E model Only)</td> </tr> <tr> <td>DV-25P</td> <td>DV format Shoots using a 576/25p signal. (E model Only)</td> <td rowspan="3">24</td> </tr> <tr> <td>DV-24P</td> <td>DV format Shoots at 480/24p (2:3:2:3 pulldown). (U model Only)</td> </tr> <tr> <td>DV-24PA</td> <td>DV format Shoots at 480/24p (2:3:3:2 pulldown). (U model Only)</td> </tr> <tr> <td>HDV-HD24P</td> <td>HDV format Shoots using a 720/24p signal.</td> <td></td> </tr> </tbody> </table> <p>CANCEL : Cancels the settings. EXECUTE : Executes the settings.</p> <p>MEMO</p> <p>* The synchronous video signal is momentarily disturbed when the REC item setting is switched. * On the E model, the video format is fixed at HDV-HD24 when the FRAME RATE item is set to "24". "[HDV-HD24]" is displayed.</p>	Setting	Description	FRAME RATE	DV-60I	DV format Shoots using a 480/60i signal. (U model Only)	60/30	HDV-SD60P	HDV format Shoots using a 480/60p signal.	HDV-HD30P	HDV format Shoots using a 720/30p signal.	HDV-SD50P	HDV format Shoots using a 576/50p signal.	50/25	HDV-HD25P	HDV format Shoots using a 720/25p signal.	DV-50I	DV format Shoots using a 576/50i signal. (E model Only)	DV-25P	DV format Shoots using a 576/25p signal. (E model Only)	24	DV-24P	DV format Shoots at 480/24p (2:3:2:3 pulldown). (U model Only)	DV-24PA	DV format Shoots at 480/24p (2:3:3:2 pulldown). (U model Only)	HDV-HD24P	HDV format Shoots using a 720/24p signal.	
Setting	Description	FRAME RATE																										
DV-60I	DV format Shoots using a 480/60i signal. (U model Only)	60/30																										
HDV-SD60P	HDV format Shoots using a 480/60p signal.																											
HDV-HD30P	HDV format Shoots using a 720/30p signal.																											
HDV-SD50P	HDV format Shoots using a 576/50p signal.	50/25																										
HDV-HD25P	HDV format Shoots using a 720/25p signal.																											
DV-50I	DV format Shoots using a 576/50i signal. (E model Only)																											
DV-25P	DV format Shoots using a 576/25p signal. (E model Only)	24																										
DV-24P	DV format Shoots at 480/24p (2:3:2:3 pulldown). (U model Only)																											
DV-24PA	DV format Shoots at 480/24p (2:3:3:2 pulldown). (U model Only)																											
HDV-HD24P	HDV format Shoots using a 720/24p signal.																											
ASPECT*	<p>Sets the screen size for the recording video signal. (Can only be displayed and set in camera mode)</p> <p>4:3 : Outputs the video with an aspect ratio of 4:3. 16:9 : Outputs the video with an aspect ratio of 16:9. The resolution in the vertical direction drops compared to 4:3 video.</p> <p>MEMO</p> <p>* When the format setting is HDV, the REC item is fixed at 16:9. "[16:9]" is displayed. * The synchronous video signal is momentarily disturbed when the ASPECT item setting is switched.</p>																											

Item	Function/Setting (bold characters indicate initial settings)																											
HDV PB OUTPUT	<p>Sets the video format to be output from the video output connector during tape playback. You can set this when the OUTPUT TERMINAL item is to "COMPONENT" or "AUTO" and you have a component output connection. You can set the following, depending on the FRAME RATE item.</p> <table border="1"> <thead> <tr> <th>Setting</th> <th>Description</th> <th>FRAME RATE</th> </tr> </thead> <tbody> <tr> <td>NATIVE</td> <td>Outputs the signal being recorded on the tape.</td> <td>60/30</td> </tr> <tr> <td>720P</td> <td>Converts the signal being recorded on tape to 720p and outputs it.</td> <td>50/25</td> </tr> <tr> <td>1080I</td> <td>Converts the signal being recorded on tape to 1080i and outputs it.</td> <td>24</td> </tr> <tr> <td>480P</td> <td>Converts the signal being recorded on tape to 480p and outputs it.</td> <td>60/30</td> </tr> <tr> <td>NTSC</td> <td>Converts the signal being recorded on tape to 480i and outputs it.</td> <td>24</td> </tr> <tr> <td>576P</td> <td>Converts the signal being recorded on tape to 576p and outputs it.</td> <td rowspan="2">50/25</td> </tr> <tr> <td>PAL</td> <td>Converts the signal being recorded on tape to 576i and outputs it.</td> </tr> </tbody> </table> <p>CAUTION</p> <p>If you convert video recorded in HDV format to DV format or vice versa and output it, the colors may change.</p>	Setting	Description	FRAME RATE	NATIVE	Outputs the signal being recorded on the tape.	60/30	720P	Converts the signal being recorded on tape to 720p and outputs it.	50/25	1080I	Converts the signal being recorded on tape to 1080i and outputs it.	24	480P	Converts the signal being recorded on tape to 480p and outputs it.	60/30	NTSC	Converts the signal being recorded on tape to 480i and outputs it.	24	576P	Converts the signal being recorded on tape to 576p and outputs it.	50/25	PAL	Converts the signal being recorded on tape to 576i and outputs it.				
Setting	Description	FRAME RATE																										
NATIVE	Outputs the signal being recorded on the tape.	60/30																										
720P	Converts the signal being recorded on tape to 720p and outputs it.	50/25																										
1080I	Converts the signal being recorded on tape to 1080i and outputs it.	24																										
480P	Converts the signal being recorded on tape to 480p and outputs it.	60/30																										
NTSC	Converts the signal being recorded on tape to 480i and outputs it.	24																										
576P	Converts the signal being recorded on tape to 576p and outputs it.	50/25																										
PAL	Converts the signal being recorded on tape to 576i and outputs it.																											
PB TAPE	<p>Selects whether to automatically detect the playback tape video format or play back only a particular format. Normally, use the "AUTO" setting.</p> <p>AUTO : During tape playback, the format signal is switched automatically and played back. DV : During tape playback, only the part of the tape recorded in DV format is played back. HDV : During tape playback, only the part of the tape recorded in HDV format is played back. DVCAM : During tape playback, only the part of the tape recorded in DVCAM format is played back.</p> <p>MEMO</p> <p>If you play back a tape containing both DV and HDV formats, the video signal is disturbed when the signal is switched.</p>																											
OUTPUT TERMINAL	<p>Sets the signal to be output from a video signal output connector (VIDEO/Y, Pb, Pr).</p> <p>AUTO : Automatically switches to a composite or component signal, depending on the status of the cables connected to the video signal output connectors, and outputs it. COMPOSITE : Outputs a composite signal regardless of the status of the cables connected to the video signal output connectors. COMPONENT : Outputs a component signal regardless of the status of the cables connected to the video signal output connectors.</p> <p>Output signals when AUTO is set</p> <table border="1"> <thead> <tr> <th colspan="3">Connector (○: Unconnected ●: Connected)</th> <th rowspan="2">Output Signal</th> </tr> <tr> <th>VIDEO/Y</th> <th>Pb</th> <th>Pr</th> </tr> </thead> <tbody> <tr> <td>●</td> <td>●</td> <td>●</td> <td>COMPONENT</td> </tr> <tr> <td>●</td> <td>○</td> <td>●</td> <td>COMPOSITE</td> </tr> <tr> <td>●</td> <td>●</td> <td>○</td> <td>COMPONENT</td> </tr> <tr> <td>●</td> <td>○</td> <td>○</td> <td>COMPOSITE</td> </tr> <tr> <td colspan="3">None of the above</td> <td>OFF</td> </tr> </tbody> </table> <p>CAUTION</p> <p>If you output video recorded in HDV format using a composite signal, the colors may change.</p>	Connector (○: Unconnected ●: Connected)			Output Signal	VIDEO/Y	Pb	Pr	●	●	●	COMPONENT	●	○	●	COMPOSITE	●	●	○	COMPONENT	●	○	○	COMPOSITE	None of the above			OFF
Connector (○: Unconnected ●: Connected)			Output Signal																									
VIDEO/Y	Pb	Pr																										
●	●	●	COMPONENT																									
●	○	●	COMPOSITE																									
●	●	○	COMPONENT																									
●	○	○	COMPOSITE																									
None of the above			OFF																									
SET UP	<p>Selects whether to add a setup signal to the video signal output from the video signal output connector. * You can also select a setup signal for IEEE1394 signal input. (GY-HD100U/GY-HD101E only)</p> <p>0.0% : No setup signal is added. 7.5% : A setup signal is added.</p> <p>Initial settings: U model: 7.5% E model: 0.0%</p> <p>MEMO</p> <p>When the FRAME RATE item is set to 50/25, this item is not displayed. The setup signal may be fixed at "0.0%" depending on the menu settings on the camcorder as well as the cables connected to it. In this case, "[0.0%]" is displayed.</p>																											
PAGE BACK	The TOP MENU returns when the SHUTTER dial is pressed with the cursor at this position.																											

MENU SCREENS

CAMERA OPERATION Menu Screen

The CAMERA OPERATION menu screen is only displayed in the Camera mode.

Item	Function/Setting (bold characters indicate initial settings)
AE LEVEL	For adjusting the image level when using auto iris, "ALC" or "EEI". Increase value: Increases level. Decrease value: Decreases level. [Settings: -3, -2, - NORMAL (0) - 2, 3]
ALC MAX	Sets the maximum "ALC" value to automatically change the signal intensity level depending on the brightness. [Setting: 6dB, 12dB, 18dB]
PRESET TEMP.	Sets the basic color temperature when the [WHT.BAL] white balance selector switch ③ on page 15 is in the PRST (PRESET) position. 3200K : Sets the basic color temperature to 3200K. (Use for light sources with a low color temperature, such as halogen lamps.) 5600K : Sets the basic color temperature to 5600K. (Use for light sources with a high color temperature, such as sunlight.) MEMO This item does not function when the FAW item on the SWITCH MODE menu screen is set to "PRESET".
SMOOTH TRANS	Smoothens the transition when the [GAIN] switch ⑫ on page 15, or [WHT.BAL] switch ③ on page 15 is switched over and achieves gradual change in place of sudden change. However, the smooth transition function does not function when switching the [GAIN] switch set in ALC, FULL AUTO ON. OFF : Deactivates the smooth transition function. ON : Activates the smooth transition function.
BARS	Sets whether or not color bars are output. (This is fixed at "OFF" when in FULL AUTO mode) OFF : Color bars are not output. ON : Color bars are output.
PAGE BACK	The TOP MENU returns when the SHUTTER dial is pressed with the cursor at this position.

MENU SCREENS

CAMERA PROCESS [1/2] Menu Screen

The CAMERA PROCESS menu screen consists of two screens. (1/2 screen, 2/2 screen)

The CAMERA PROCESS menu screen is only displayed in camera mode.

Item	Function/Setting (bold characters indicate initial settings)
MASTER BLACK	Adjusts the pedestal level (master black) that serves as the reference black. Increase the number : Raises the pedestal level. Decrease the number : Lowers the pedestal level. [Settings: MIN (-10), -9 - NORMAL (0) - 9, MAX (10)]
DETAIL	Adjusts the contour (detail) sharpness level. Increase the number : Sharpens the contour. Decrease the number : Softens the contour. OFF : Does not function. [Settings: OFF, MIN (-10), -9 - NORMAL (0) - 9, MAX (10)] When this item is set to "OFF", "----" is displayed for the following menu items and they cannot be selected.
V/H BALANCE	Sets which contours (details) to sharpen, those in the horizontal (H) direction or those in the vertical (V) direction. Increase the number : Sharpens H direction. Decrease the number : Sharpens V direction. [Settings: H-MIN (-5), -4 - NORMAL (0) - 4, H-MAX (5)]
H FREQUENCY	Changes the horizontal contour compensation frequency for the contours (details). Set this as appropriate for the subject. LOW : Enhances low frequency bands. Use this when shooting subjects with large patterns. MIDDLE : Enhances middle frequency bands. HIGH : Enhances high frequency bands. Use this when shooting subjects with small patterns.
V FREQUENCY ^{*1}	Use this when shooting subjects with finely detailed patterns. Changes the vertical contour compensation frequency for the contours (details). Compensates for distortion when outputting progressive video to an interlaced monitor. HIGH : Enhances high frequency bands. LOW : Enhances low frequency bands.
SKIN DETECT	Sets ON/OFF for the skin detail function. OFF : Turns off the skin detail function. ON : Turns on the skin detail function. (Softens detected skin color area details.) * See "Using the Skin Detail Function" on page 83.
LEVEL	Sets the contour compensation level (amount of softening) for the skin detail function. This can only be selected when the SKIN DETECT item is set to ON. -1 : Low contour compensation level (amount of softening) -2 : Medium contour compensation level (amount of softening) -3 : High contour compensation level (amount of softening)
BLACK	Changes the gain in dark areas. Change this depending on the video signal being shot. STRETCH1 : Enhances the dark areas of the video so the contrast between light and dark is more visible by stretching the signal only in the dark areas. STRETCH2 : The amount of stretching increases from STRETCH1→STRETCH2→STRETCH3. STRETCH3 : Normal status NORMAL : Normal status COMPRESS1 : If the video that was shot is bright overall and lacking in contrast, the gain in the dark areas is compressed, which adds contrast. COMPRESS2 : The amount of compression increases from COMPRESS1→COMPRESS2→COMPRESS3. COMPRESS3 : The amount of compression increases from COMPRESS1→COMPRESS2→COMPRESS3.
NEXT PAGE	To display the CAMERA PROCESS [2/2] menu screen, move the cursor to this position and press the SHUTTER dial.
PAGE BACK	The TOP MENU returns when the SHUTTER dial is pressed while the cursor is at this position.

*1 When the REC item on the VIDEO FORMAT menu is set to "DV-60i" or "DV-50i", "----" is displayed and this cannot be selected.

CAMERA PROCESS [2/2] Menu Screen

Item	Function/Setting (bold characters indicate initial settings)
WHITE CLIP	Sets the white clipping point on input video signals with a high luminance level. 108% : The white clipping point is set at a luminance level of 108%. 100% : The white clipping point is set at a luminance level of 100%. If the screen is too white at 108%, set it to 100%.
KNEE	Sets whether to run the "knee" function, which compresses video signals over a certain level to render the tonality in the highlight areas, automatically or manually. Set "MANUAL" when you want to check the bright areas, and adjust the knee point manually. AUTO : Adjusts the knee point automatically, according to the luminance level. MANUAL : You can change the luminance level in the "LEVEL" item.
LEVEL	Sets the start point for knee compression (knee point). Increase the number : Raises the knee point level. Decrease the number : Lowers the knee point level. [Settings: 80%, 85%, 90%, 95%, 100%] MEMO When the "KNEE" item is set to "AUTO", "-----" is displayed and this cannot be selected.
MOTION SMOOTH	Makes the video smoother when the tape is played back by adding frames to the signal recorded on the tape during progressive shooting. OFF : Does not function. ON : Functions. MEMO This can be set when you select "HDV-HD30p", "HDV-HD25p", or "HDV-HD24p" in the "REC" item on the VIDEO FORMAT menu screen. When this cannot be set, "-----" is displayed.
ADVANCED PROCESS..	Calls up the ADVANCED PROCESS menu screen. ⓘ See "ADVANCED PROCESS Menu Screen" on page 67.
PAGE BACK	When the cursor is in this position, press the SHUTTER dial to return to the CAMERA PROCESS [1/2] menu screen.

ADVANCED PROCESS Menu Screen

Item	Function/Setting (bold characters indicate initial settings)
CINEMA MODE	OFF : Turns the function OFF. ON : Sets the gamma characteristics and color matrix close to the characteristics of a movie screen. MEMO When this item is set to "ON", "CINEMA" is displayed for COLOR MATRIX and GAMMA items and cannot be selected.
COLOR MATRIX	Sets the color matrix. OFF : Turns the function OFF. STANDARD : Sets a normal color matrix. CINEMA : Sets a color matrix close to the characteristics of a movie screen.
ADJUST..	When "STANDARD" or "CINEMA" is set for the COLOR MATRIX item, a color matrix can be set individually. Press the SHUTTER dial to call up the COLOR MATRIX ADJUST menu screen. ⓘ See "COLOR MATRIX ADJUST Menu Screen" on page 68.
GAMMA	Adjusts the gamma curve to determine how black is rendered. OFF : Turns the function OFF. STANDARD : Sets a normal gamma curve. CINEMA : Sets a gamma curve close to the characteristics of a movie screen. MEMO When this item is set to "OFF", "-----" is displayed for the LEVEL item and it cannot be selected.
LEVEL	When "STANDARD" or "CINEMA" is set for the GAMMA item, a gamma curve can be set individually. Increase the number : Enhances the tonality of the black. However, the tonality in the bright areas deteriorates. Decrease the number : Enhances the tonality in the bright areas. However, the tonality in the black areas deteriorates. [Settings: MIN (-5), -4 - NORMAL (0) - 4, MAX (5)]
COLOR GAIN	Adjusts the video signal color level. OFF : Sets the video to black and white. Increase the number : Makes the colors more dense. Decrease the number : Makes the colors less dense. [Settings: OFF, MIN (-10), -9 - NORMAL (0) - 9, MAX (10)]
WHITE PAINT<R>	Adjusts the R (red) component when in AWB (Auto White Balance) mode. Increase the number : Strengthens the red. Decrease the number : Weakens the red. [Settings: MIN (-32), -31 - NORMAL (0) - 30, MAX (31)] MEMO <ul style="list-style-type: none"> You can select this when A or B is set for the [WHT.BAL] switch ⓘ on the right panel of the camcorder. ⓘ See page 15. Settings can be made for A and B individually. (When "PRESET" is set, "-----" is displayed and this cannot be selected.) When you press the AWB (Auto White Balance) button and readjust the white balance, WHITE PAINT R becomes "NORMAL".
WHITE PAINT	Adjusts the B (blue) component when in AWB (Auto White Balance) mode. Increase the number : Strengthens the blue. Decrease the number : Weakens the blue. [Settings: MIN (-32), -31 - NORMAL (0) - 30, MAX (31)] MEMO <ul style="list-style-type: none"> You can select this when A or B is set for the [WHT.BAL] switch ⓘ on the right panel of the camcorder. ⓘ See page 15. Settings can be made for A and B individually. (When "PRESET" is set, "-----" is displayed and this cannot be selected.) When you press the AWB (Auto White Balance) button and readjust the white balance, WHITE PAINT B becomes "NORMAL".
SKIN COLOR ADJUST	When the cursor is in this position and you press the SHUTTER dial once, the screen switches to the SKIN COLOR ADJUST screen.
PAGE BACK	When the cursor is in this position, press the SHUTTER dial to return to the CAMERA PROCESS [2/2] menu screen.

MENU SCREENS

COLOR MATRIX ADJUST Menu Screen

Item	Function/Setting (bold characters indicate initial settings)
R GAIN	For manually adjusting the shading of the R axis of the color matrix (red and cyan). Increase the number : Enhances red and cyan. Decrease the number : Reduces red and cyan. [Settings: MIN (-5), -4 - NORMAL (0) - 4, MAX (5)]
R ROTATION	For manually adjusting the color phase of the R axis of the color matrix (red and cyan). Increase the number : Increases yellowishness of red color and bluishness of cyan color. Decrease the number : Increases bluishness of red color and greenishness of cyan color. [Settings: MIN (-5), -4 - NORMAL (0) - 4, MAX (5)]
G GAIN	For manually adjusting the shading of the G axis of the color matrix (green and magenta). Increase the number : Enhances green and magenta. Decrease the number : Reduces green and magenta. [Settings: MIN (-5), -4 - NORMAL (0) - 4, MAX (5)]
G ROTATION	For manually adjusting the color phase of the G axis of the color matrix (green and magenta). Increase the number : Increases bluishness of green color and reddishness of magenta color. Decrease the number : Increases yellowishness of green color and bluishness of magenta color. [Settings: MIN (-5), -4 - NORMAL (0) - 4, MAX (5)]
B GAIN	For manually adjusting the shading of the B axis of the color matrix (blue and yellow). Increase the number : Enhances blue and yellow. Decrease the number : Reduces blue and yellow. [Settings: MIN (-5), -4 - NORMAL (0) - 4, MAX (5)]
B ROTATION	For manually adjusting the color phase of the B axis of the color matrix (blue and yellow). Increase the number : Increases reddishness of blue color and greenishness of yellow color. Decrease the number : Increases greenishness of blue color and reddishness of yellow color. [Settings: MIN (-5), -4 - NORMAL (0) - 4, MAX (5)]
PAGE BACK	Press the SHUTTER dial to return to the ADVANCED PROCESS screen when cursor is at this position.

SKIN COLOR ADJUST Menu Screen

When you enter the SKIN COLOR ADJUST screen, the areas where the skin detail function is applied are displayed in color, and other areas are displayed in black and white.

Item	Function/Setting (bold characters indicate initial settings)
SKIN COLOR DET.	Sets the color used by the skin detail function. STOP : Stops loading the color used by the skin detail function. EXECUTE : Loads the color used by the skin detail function. * See "Using the Skin Detail Function" on page 83.
SKIN COLOR RANGE	Adjusts the range of skin colors to which the skin detail function is applied. Adjust as you check the color range. Increase the number : Widens the range. Decrease the number : Narrows the range. [Settings: NARROW (-10), -9 - NORMAL (0) - 9, WIDE (10)] MEMO When the COLOR GAIN item is "OFF" on the ADVANCED PROCESS menu screen, only the areas where the skin detail function is running are displayed using skin colors.
PAGE BACK	When the cursor is in this position, press the SHUTTER dial to return to the ADVANCED PROCESS menu screen.

MENU SCREENS

SWITCH MODE Menu Screen

The SWITCH MODE menu screen is only displayed in camera mode.

Item	Function/Setting (bold characters indicate initial settings)												
SHUTTER	Sets the fixed value (STEP) for values that can change using the SHUTTER dial on the right panel or the VARIABLE used when shooting computer monitors. STEP : Switches the shutter speed using fixed values. VARIABLE : Set when shooting a computer monitor, etc. You can set the following using the REC item on the VIDEO FORMAT menu screen. (This is fixed at EEI when in FULL AUTO mode)												
	<table border="1"> <thead> <tr> <th>REC Item</th> <th>Setting for STEP</th> <th>Setting for VARIABLE</th> </tr> </thead> <tbody> <tr> <td>DV-60I HDV-SD60P HDV-HD30P</td> <td>1/7.5, 1/15, 1/30, 1/60, 1/100, 1/250, 1/500, 1/1000, 1/2000, 1/4000, 1/10000</td> <td>1/60.19 - 1/1998.0</td> </tr> <tr> <td>DV-50I HDV-SD50P HDV-HD25P DV-25P</td> <td>1/6.25, 1/12.5, 1/25, 1/50, 1/120, 1/250, 1/500, 1/1000, 1/2000, 1/4000, 1/10000</td> <td>1/50.20 - 1/1973.6 1/25.05 - 1/1973.6</td> </tr> <tr> <td>DV-24P DV-24PA HDV-HD24P</td> <td>1/6, 1/12, 1/24, 1/48, 1/60, 1/100, 1/250, 1/500, 1/1000, 1/2000, 1/4000, 1/10000</td> <td>1/24.01 - 1/1998.0 1/48.11 - 1/1998.0</td> </tr> </tbody> </table>	REC Item	Setting for STEP	Setting for VARIABLE	DV-60I HDV-SD60P HDV-HD30P	1/7.5, 1/15, 1/30, 1/60 , 1/100, 1/250, 1/500, 1/1000, 1/2000, 1/4000, 1/10000	1/60.19 - 1/1998.0	DV-50I HDV-SD50P HDV-HD25P DV-25P	1/6.25, 1/12.5, 1/25, 1/50 , 1/120, 1/250, 1/500, 1/1000, 1/2000, 1/4000, 1/10000	1/50.20 - 1/1973.6 1/25.05 - 1/1973.6	DV-24P DV-24PA HDV-HD24P	1/6, 1/12, 1/24 , 1/48, 1/60, 1/100, 1/250, 1/500, 1/1000, 1/2000, 1/4000, 1/10000	1/24.01 - 1/1998.0 1/48.11 - 1/1998.0
REC Item	Setting for STEP	Setting for VARIABLE											
DV-60I HDV-SD60P HDV-HD30P	1/7.5, 1/15, 1/30, 1/60 , 1/100, 1/250, 1/500, 1/1000, 1/2000, 1/4000, 1/10000	1/60.19 - 1/1998.0											
DV-50I HDV-SD50P HDV-HD25P DV-25P	1/6.25, 1/12.5, 1/25, 1/50 , 1/120, 1/250, 1/500, 1/1000, 1/2000, 1/4000, 1/10000	1/50.20 - 1/1973.6 1/25.05 - 1/1973.6											
DV-24P DV-24PA HDV-HD24P	1/6, 1/12, 1/24 , 1/48, 1/60, 1/100, 1/250, 1/500, 1/1000, 1/2000, 1/4000, 1/10000	1/24.01 - 1/1998.0 1/48.11 - 1/1998.0											
FAW	Sets the positions to assign the FAW (Full Auto White Balance) function to the [WHT.BAL] white balance selector switch ⑬ on page 15. (Fixed at FAW when in FULL AUTO mode) NONE : The FAW function is not assigned. A : Assigns FAW to the A position. B : Assigns FAW to the B position. PRESET : Assigns FAW to the PRESET position.												
GAIN L GAIN M GAIN H	Sets the gain value for each position on the [GAIN] sensitivity selector switch ⑫ on page 15. [Setting: 0dB, 3dB, 6dB, 9dB, 12dB, 15dB, 18dB, ALC] (Fixed at ALC in FULL AUTO mode) Initial values: L: 0dB, M: 9dB, H: 18dB												
USER1 USER2 USER3	You can assign one of the following menu functions to the [USER1/2/3] USER1/2/3 buttons ⑧ on page 14 to each button. Set according to the shooting conditions.												
	<table border="1"> <thead> <tr> <th>Setting</th> <th>Description</th> </tr> </thead> <tbody> <tr> <td>NONE</td> <td>Does not function.</td> </tr> <tr> <td>BARS PRESET TEMP.</td> <td>Assigns "BARS" item functions in the CAMERA OPERATION menu screen. Assigns "PRESET TEMP." item functions in the CAMERA OPERATION menu screen. * See "CAMERA OPERATION Menu Screen" on page 64.</td> </tr> <tr> <td>B.STRETCH1 B.STRETCH2 B.STRETCH3 B.COMPRESS1 B.COMPRESS2 B.COMPRESS3</td> <td>Assigns "BLACK" item functions in the CAMERA PROCESS [1/2] menu screen. * See "CAMERA PROCESS [1/2] Menu Screen" on page 65.</td> </tr> <tr> <td>AE LEVEL+ AE LEVEL-</td> <td>Assigns "AE LEVEL" item functions in the CAMERA OPERATION menu screen. MEMO Cannot assign to the USER3 button. If you assign these menu functions, assign AE LEVEL+ to the USER1 button, AE LEVEL- to the USER2 button.</td> </tr> </tbody> </table>	Setting	Description	NONE	Does not function.	BARS PRESET TEMP.	Assigns "BARS" item functions in the CAMERA OPERATION menu screen. Assigns "PRESET TEMP." item functions in the CAMERA OPERATION menu screen. * See "CAMERA OPERATION Menu Screen" on page 64.	B.STRETCH1 B.STRETCH2 B.STRETCH3 B.COMPRESS1 B.COMPRESS2 B.COMPRESS3	Assigns "BLACK" item functions in the CAMERA PROCESS [1/2] menu screen. * See "CAMERA PROCESS [1/2] Menu Screen" on page 65.	AE LEVEL+ AE LEVEL-	Assigns "AE LEVEL" item functions in the CAMERA OPERATION menu screen. MEMO Cannot assign to the USER3 button. If you assign these menu functions, assign AE LEVEL+ to the USER1 button, AE LEVEL- to the USER2 button.		
Setting	Description												
NONE	Does not function.												
BARS PRESET TEMP.	Assigns "BARS" item functions in the CAMERA OPERATION menu screen. Assigns "PRESET TEMP." item functions in the CAMERA OPERATION menu screen. * See "CAMERA OPERATION Menu Screen" on page 64.												
B.STRETCH1 B.STRETCH2 B.STRETCH3 B.COMPRESS1 B.COMPRESS2 B.COMPRESS3	Assigns "BLACK" item functions in the CAMERA PROCESS [1/2] menu screen. * See "CAMERA PROCESS [1/2] Menu Screen" on page 65.												
AE LEVEL+ AE LEVEL-	Assigns "AE LEVEL" item functions in the CAMERA OPERATION menu screen. MEMO Cannot assign to the USER3 button. If you assign these menu functions, assign AE LEVEL+ to the USER1 button, AE LEVEL- to the USER2 button.												
LENS RET	Sets the lens RET button functions. (This does not function if there is not RET button on the lens you are using.) RET : Functions as a normal RET button. FOCUS ASSIST : Functions as the FOCUS ASSIST button.												
PAGE BACK	When the cursor is in this position, press the SHUTTER dial to return to the TOP MENU screen.												

AUDIO/MIC Menu Screen

In VTR mode, the screen changes to the AUDIO menu screen.

* This is not displayed in VTR mode.

Item	Function/Setting (bold characters indicate initial settings)
TEST TONE	Sets whether to output a test audio signal (1kHz, -20dBFS or -12dBFS) during color bar output. OFF : A test audio signal is not output. ON : A test audio signal is output.
MIC WIND CUT*	Selects whether to cut the lows (low frequency bands) from the audio input signal. Use this when you want to reduce wind sounds from the microphone. OFF : Low frequencies are not cut. INPUT1 : Only cuts the low frequencies in the audio from the INPUT1 connector. INPUT2 : Only cuts the low frequencies in the audio from the INPUT2 connector. BOTH : Cuts the low frequencies in the audio from both the INPUT1 and INPUT2 terminals.
AUDIO REF LEVEL	Sets the reference audio level on the tape. (Both CH-1 and CH-2) -20dB : Records with -20 dB as the reference audio level. -12dB : Records with -12 dB as the reference audio level. Set this if you are playing back the recorded tape on an ordinary DV device. * Set this for both playback and recording. * This is unrelated to the audio level via the IEEE1394 signal.
INPUT1 MIC REF.*	Sets the reference audio input level for the INPUT1 connector. -50dB : Sets the reference audio input level at -50 dB. -60dB : Sets the reference audio input level at -60 dB.
INPUT2 MIC REF.*	Sets the reference audio input level for the INPUT2 connector. -50dB : Sets the reference audio input level at -50 dB. -60dB : Sets the reference audio input level at -60 dB.
AUDIO MONITOR	Selects whether stereo or mixed audio is output from the PHONES jack when the MONITOR SELECT switch is set to BOTH. STEREO : Stereo audio (CH-1 audio is output to L and CH-2 audio is output to R) * Outputs only the CH-1 audio from the monitor speaker. MIX : Mixed audio (CH-1 and CH-2 mixed audio is output to L and R)
AUDIO MODE*	Selects the audio sampling frequency for recording. (Both CH-1 and CH-2) (When HDV format is set, this is fixed at 48K and "[48K]" is displayed.) 32K : Digitally records with a 12-bit, 32 kHz sampling frequency. 48K : Digitally records with a 16-bit, 48 kHz sampling frequency. * If the DV format is 12-bit, 32 kHz, up to 4 recording track channels are available. Of those, this camcorder records on the CH-1 and CH-2 channels. This camcorder is not capable of dubbing.
SEARCH AUDIO [DV]	Selects whether to output audio when searching a tape recorded in DV format. (This also includes slow playback.) ON : Audio is output. OFF : Audio is not output.
PB AUDIO CH [DV]	Selects which channel audio to output when playing back a DV tape with the audio signal recorded in 4 channels. (Can only be set in VTR mode) CH1/2 : Outputs the CH-1 and CH-2 channel audio. This camcorder records the audio in CH-1 and CH-2 while shooting. MIX : Outputs all 4 channels of audio at the same time. CH3/4 : Outputs the CH-3 and CH-4 channel audio. MEMO This camcorder does not have a function for dubbing to the CH-3 and CH-4 channels.
PAGE BACK	When the cursor is in this position, press the SHUTTER dial to return to the TOP MENU screen.

LCD/VF [1/3] Menu Screen

The LCD/VF menu screen consists of three screens. (1/3 screen, 2/3 screen, 3/3 screen)

The LCD/VF [1/3] menu screen can only be set in camera mode.

In VTR mode, this screen consists of two screens. (1/2 screen, 2/2 screen)

Item	Function/Setting (bold characters indicate initial settings)
ZEBRA	Switches the luminance level of the subject sections where the zebra pattern is displayed. 60-70% : Zebra pattern is displayed in sections with luminance levels between 60% and 70%. 70-80% : Zebra pattern is displayed in sections with luminance levels between 70% and 80%. 85-95% : Zebra pattern is displayed in sections with luminance levels between 85% and 95%. OVER95% : Zebra pattern is displayed in sections with luminance levels over 95%. OVER100% : Zebra pattern is displayed in sections with luminance levels over 100%.
F. NO/IRIS IND.	Selects whether or not the F-number of the lens iris/iris level mark is displayed in the status display on the LCD monitor or in the viewfinder. (STATUS 1 screen) OFF : F-number and iris level mark is not displayed. F.NO : F-number is displayed. F.NO+IND. : F-number and iris level mark is displayed.
FILTER	Selects whether or not the FILTER position of the unit is displayed in the status display on the LCD monitor or in the viewfinder. (STATUS 1 screen) OFF : FILTER position is not displayed. ON : FILTER position is displayed.
SAFETY ZONE*1	Selects whether or not the safety zone is shown on the LCD monitor or in the viewfinder together with the form of the safety zone indication. OFF : Not displayed 4:3 : 4:3 zone is displayed. 14:9 : 14:9 zone is displayed. 16:9 : 16:9 zone is displayed. 16:9+4:3 : 16:9 zone and 4:3 zone are display mixed. (This cannot be selected when DV format is set.)
CENTER MARK*1	Sets whether or not a center mark is displayed when the safety zone is displayed. ON : Center mark is displayed. OFF : Center mark is not displayed. MEMO When the SAFETY ZONE item is set to OFF, "- -" is indicated and this item cannot be selected.
FOCUS ASSIST	Sets the display color for focusing when running the FOCUS ASSIST function. BLUE : Displays the area of focus in blue. RED : Displays the area of focus in red. GREEN : Displays the area of focus in green.
NEXT PAGE	When you display the LCD/VF [2/3] menu screen, move the cursor to this position and press the SHUTTER dial.
PAGE BACK	When the cursor is in this position, press the SHUTTER dial to return to the TOP MENU screen.

*1 SAFETY ZONE and CENTER MARK will not be displayed when the camcorder is in VTR mode (PLAY, STL, FWD, REV).

MENU SCREENS

LCD/VF [2/3] Menu Screen

[1/2] screen is displayed in the VTR mode.

Item	Function/Setting (bold characters indicate initial settings)
VIDEO FORMAT	Selects whether to display the video format in the status display on the LCD monitor or the viewfinder. (Camera mode: STATUS 1 screen, VTR mode: STATUS screen) ON : Displays the video format. OFF : Does not display the video format. In camera mode : Displays the video format set in the REC item on the VIDEO FORMAT menu screen. In VTR mode : Displays the video format recorded on the playback tape or the video format input from the IEEE1394 connector.
TAPE REMAIN	Selects whether or not the remaining tape time (minutes) is shown in the status display on the LCD monitor or in the viewfinder. (Camera mode: STATUS 1 screen, VTR mode: STATUS screen) ON : Displayed. OFF : Not displayed.
TC/UB	Selects whether or not the time code or user's bits data should be shown in the status display on the LCD monitor or in the viewfinder. (Camera mode: STATUS 1 screen, VTR mode: STATUS screen) OFF : Not displayed. ON : Displayed. * Whether the time code or user's bits data is shown is selected with the TC DISPLAY switch.
AUDIO	Selects whether the audio level meters should be shown in the status display on the LCD monitor and the viewfinder screen. (Camera mode: STATUS 1 screen, VTR mode: STATUS screen) OFF : Not displayed. ON : Displayed.
NEXT PAGE	Camera mode: To display the LCD/VF [3/3] menu screen, move the cursor to this position and press the SHUTTER dial. VTR mode: To display the LCD/VF [2/2] menu screen, move the cursor to this position and press the SHUTTER dial.
PAGE BACK	Camera mode: When the cursor is in this position, press the SHUTTER dial to return to the LCD/VF [1/3] menu screen. VTR mode: When the cursor is in this position, press the SHUTTER dial to return to the TOP MENU screen.

MENU SCREENS

LCD/VF [3/3] Menu Screen

[2/2] screen is displayed in the VTR mode.

Item	Function/Setting (bold characters indicate initial settings)
LCD CONTRAST	Adjusts the contrast of the LCD. [Settings: MIN (-5), -4 - NORMAL (0) - 4, MAX (5)]
VF CONTRAST	Adjusts the contrast of the viewfinder. [Settings: MIN (-5), -4 - NORMAL (0) - 4, MAX (5)]
PAGE BACK	Camera mode: When the cursor is in this position, press the SHUTTER dial to return to the LCD/VF [2/3] menu screen. VTR mode: When the cursor is in this position, press the SHUTTER dial to return to the LCD/VF [1/2] menu screen.

TC/UB/CLOCK Menu Screen

Time codes (TC) and user's bits (UB) can be set on this screen. Date and time is set on the TIME/DATE screen that can be reached from this screen.

Item	Function/Setting (bold characters indicate initial settings)
TC PRESET	To preset the time code, align the cursor with this position and then press the SHUTTER dial. EXECUTE : The set time code is confirmed. CANCEL : The set time code is cancelled. ZERO PRESET : Resets all time codes to "0".
UB PRESET	To preset the user's bit data, align the cursor with this position and then press the SHUTTER dial. EXECUTE : The set user's bit data are confirmed. CANCEL : The set user's bit data are cancelled. ZERO PRESET : Resets all user's bits data to "0". MEMO When the "UB REC" item is set to "OFF", "-----" is displayed and this cannot be selected.
DROP/NON DROP*1	Selects whether the timecode generator framing mode is drop-frame or non-drop-frame. DROP : Internal timecode generator works in drop-frame mode. Set this when the recorded time is important. NON DROP : Internal timecode generator works in non-drop-frame mode. Set this when the number of frames is important.
UB REC*2	To select whether or not user's bit data should be recorded. To select whether the user's bits should be displayed during playback of a tape with recorded user's bits data. ON : User's bits are recorded during recording. User's bits are displayed during playback. OFF : User's bits are not recorded during recording. User's bits are not displayed during playback.
TC DUPLI. [DV]	Sets how to record the timecode (TC) and user's bits (UB) during IEEE1394 input of DV format. OFF : Records the TC/UB set in the camcorder. ON : Records the TC/UB of the IEEE1394 input. MEMO In HDV format, the TC/UB set in the camcorder is recorded regardless of the setting.
HEADER REC	To make settings related to the HEADER REC function, align the cursor with this position, and then press the SHUTTER dial. * See "HEADER REC Menu Screen" on page 75.
TIME/DATE	To make settings related to the date and time, align the cursor with this position and then press the SHUTTER dial. * See "TIME/DATE Menu Screen" on page 76.
PAGE BACK	When the cursor is in this position, press the SHUTTER dial to return to the TOP MENU screen.

*1 This can be displayed and selected when 60/30 is set for the FRAME RATE item on the VIDEO FORMAT menu screen. When 24 is set, this is fixed at "NON DROP" and "[NON DROP]" is displayed.

*2 This can be displayed and selected when 50/25 is set for the FRAME RATE item on the VIDEO FORMAT menu screen.

HEADER REC Menu Screen

The HEADER REC menu screen is used for settings related to the HEADER REC function. (* See page 50.)

Item	Function/Setting (bold characters indicate initial settings)
START KEY	Sets whether the HEADER REC operation should be executed when the REC/VTR trigger button is pressed while the STOP button is pressed. DISABLE : HEADER REC operation is not executed. STOP+REC : HEADER REC operation is executed.
TC DATA	Sets the time code value for the point when the Record-Standby mode is engaged following completion of HEADER REC. EXECUTE : Confirms the set time code. ZERO PRESET : Resets all time codes to "0". CANCEL : Clears the set time code. The frame mode is set depending on the setting in the DROP/NON DROP item on the TC/UB/CLOCK menu screen. * The time code value at the point when the Record-Standby mode is engaged may differ some frames from the value set for this item.
UB DATA	Sets the user's bits of the HEADER REC section. EXECUTE : Confirms the set user's bits. ZERO PRESET : Resets all user's bits data to "0". CANCEL : Clears the set user's bits. MEMO • The user's bits for the normal recording section are set on the TC/UB/CLOCK menu screen. • When the "UB REC" item is set to "OFF", "-----" is displayed and this cannot be selected.
BARS TIME	Sets the duration (seconds) in which the color bar signal and test tone (1 kHz) is recorded during HEADER REC. (1-sec steps) [Settings: 0SEC - 30SEC - 99SEC]
BLACK TIME	Sets the duration (seconds) in which the black signal is recorded during HEADER REC. (1-sec steps) [Settings: 0SEC - 30SEC - 99SEC]
PAGE BACK	The TC/UB/CLOCK menu screen returns when the SHUTTER dial is pressed.

MENU SCREENS

TIME/DATE Menu Screen

Item	Function/Setting (bold characters indicate initial settings)
DISPLAY	Sets whether the date and time are shown in the status display on the LCD monitor or in the viewfinder. OFF : Not displayed. ON : Displayed. When a tape with time and date not recorded is played back, there will be no display of time and date even when this item is set to ON.
DISPLAY MODE	In the Camera mode, the date and time are displayed in accordance with the following settings. In the VTR mode, if the DATE REC item is set to OFF, the date and time recorded on a tape are displayed in accordance with the following settings. BARS+CAM : Date and time are always displayed. BARS : Date and time are displayed when the color bars are output. CAM : Date and time are displayed when the camera images are output. When the DISPLAY item is set to OFF, "-" is indicated and this item cannot be selected.
DISPLAY STYLE	Selects the style for the date and time display. DATE+TIME : Date and time are displayed. DATE : Date only is displayed. TIME : Time only is displayed. When the DISPLAY item is set to OFF, "-" is indicated and this item cannot be selected.
DATE STYLE	Selects the style for the date display. YY/MM/DD : Displayed in the format of year/month/date. MM/DD/YY : Displayed in the format of month/date/year. DD/MM/YY : Displayed in the format of date/month/year. Variation Range: U model: MM/DD/YY E model: DD/MM/YY When the DISPLAY item is set to OFF, "-" is indicated and this item cannot be selected.
TIME STYLE	Selects the style for the time display. 24 HOUR : Displays the time using the 24-hour system. 12 HOUR : Displays the time using the 12-hour system. When the DISPLAY item is set to OFF, "-" is indicated and this item cannot be selected.
SEC DISPLAY	Selects whether to display the seconds in the time display. ON : Seconds are displayed. OFF : Seconds are not displayed. When the DISPLAY item is set to OFF, "-" is indicated and this item cannot be selected.
TIME SHIFT	Sets the clock OFFSET time. (1H steps) Adds time to the built-in clock (time compensation) and displays it. The adjusted time is also recorded on the tape. [Settings: -23H - 1H, OFF , +H - +23H]
CLOCK ADJUST	To adjust the date and time, align the cursor with this position and then press the SHUTTER dial. The date and time are set on the CLOCK ADJUST screen. ⓘ See 'Setting the Date and Time' on page 37.
PAGE BACK	The TC/UB/CLOCK menu returns when the SHUTTER dial is pressed while the cursor is at this position.

MENU SCREENS

OTHERS [1/2] Menu Screen

The OTHERS menu screen consists of two screens (1/2 screen, 2/2 screen)

Item	Function/Setting (bold characters indicate initial settings)
OUTPUT CHAR.	Selects whether to display the menu screen or the warning display on the monitor connected to the video signal output connector. ON : On-screen-display OFF : No on-screen-display
LONG PAUSE TIME	Selects the time (minutes) before the tape protect mode (drum head rotation stopped) is engaged when the record-standby condition continues. 3MIN : 3 minutes 5MIN : 5 minutes * When used in a cold environment or when the stopped or STILL status continues, the setting will be 3 minutes or less regardless of the setting on the menu. * Normally, set "3MIN" and use this to prevent head clogging and tape damage.
ALARM VR LEVEL	Selects whether or not alarm sound is emitted and the volume of the alarm sound. The alarm sound is output through the monitoring loudspeaker and the PHONES jack. OFF : Sound is not output. LOW : Alarm sound is soft. MIDDLE : Alarm sound is normal. HIGH : Alarm sound is loud.
FRONT TALLY	Selects the lighting method of the FRONT TALLY lamp during recording. BLINK : The lamp blinks from when the REC/VTR trigger is pressed and until recording starts. The lamp lights steadily during recording. ON : The lamp lights only during recording. OFF : The lamp is always off.
BACK TALLY	Selects the lighting method of the BACK TALLY lamp during recording. BLINK : The lamp blinks from when the REC/VTR trigger is pressed and until recording starts. The lamp lights steadily during recording. ON : The lamp lights only during recording. OFF : The lamp is always off.
FORMAT LED	Sets whether or not the [HDV/DV LED] ⓘ on page 15 lights for HDV format or DV format. ON : Lights. OFF : Does not light.
NEXT PAGE	To display the OTHERS [2/2] menu screen, move the cursor to this position and press the SHUTTER dial.
PAGE BACK	The TOP MENU screen returns when the SHUTTER dial is pressed while the cursor is at this position.

OTHERS [2/2] Menu Screen

* This is not displayed in VTR mode.

Item	Function/Setting (bold characters indicate initial settings)
1394 REC TRIGGER*	<p>Sets how to control the REC trigger command output from the IEEE1394 connector. (Can be displayed and set in camera mode)</p> <p>Set this when recording a backup of the DV signal from this camcorder onto another device.</p> <p>OFF : Does not control the backup device.</p> <p>SYNCR0 : Controls the backup device in conjunction with the recording start/stop mode status on the camcorder, and if there is no videocassette or if no tape remains for recording, controls the backup device in conjunction with the REC trigger button and the lens VTR button on the camcorder.</p> <p>SPLIT : The REC trigger button on the right panel of the camcorder controls the backup device recording start/stop. Set this when you want to control the timing of the recording on the camcorder and the backup device separately.</p> <p>SERIES : Automatically starts recording on a backup device that is on Pause when the tape on the camcorder has less than 3 minutes remaining during shooting.</p> <p>MEMO</p> <ul style="list-style-type: none"> If you use the backup recording function on the BR-HD50, set this item to OFF. The cursor (▶) does not move to this item when the camcorder is recording.
MENU ALL RESET	<p>Selects whether to reset the menu screen settings to initial settings.</p> <p>The camera mode and VTR mode menu settings are reset. (The TC PRESET, UB PRESET, and CLOCK ADJUST settings are not reset.)</p> <p>CANCEL : The settings are not reset.</p> <p>EXECUTE : The settings are reset.</p> <p>MEMO</p> <ul style="list-style-type: none"> The cursor (▶) does not move to this item when the camcorder is in VTR mode or is ejecting a tape. If the current menu settings and the factory settings have different FRAME RATE settings, "REBOOT!" is displayed for 3 seconds, the camcorder automatically turns off and then turns on.
PAGE BACK	When the cursor is in this position, press the SHUTTER dial once to return to the OTHERS [1/2] menu screen.
DRUM HOUR	<p>Displays the drum usage time.</p> <p>Use as an estimate for regular maintenance.</p> <p>The cursor (▶) does not move to this item.</p>
FAN HOUR	<p>Displays the fan motor usage time.</p> <p>Use as an estimate for regular maintenance.</p> <p>The cursor (▶) does not move to this item.</p>

FILE MANAGE Menu Screen

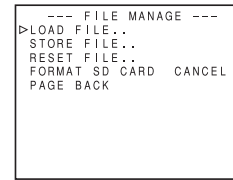

FILE MANAGE menu screen

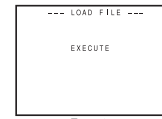
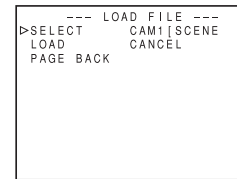

Execute



Complete

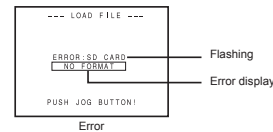

Error



Reboot display

You can perform the following operations in the FILE MANAGE menu screen.

- Settings corresponding to shooting conditions can be read immediately with the following read-only files.
 - LIVE HD30P: Ideal setting for HD30P format
 - LIVE HD25P: Ideal setting for HD25P format
 - CINEMA HD24P: Ideal setting for movie film shooting
- * The read-only files listed above cannot be saved or reset.
- Save menu settings (Camcorder: CAM1, CAM2; SD memory card: EXT1, 2, 3, 4) to files.
- Load saved files.
- You can set a SUB NAME for the file to be saved.
- Reset the menu settings to the factory settings.
- Initialize (format) an SD memory card.
- When you set CANCEL for the LOAD, STORE, RESET and FORMAT SD CARD items, these operations are not executed.
- A message is displayed in the LCD monitor or the viewfinder.
 - Execute : Displayed for 3 seconds
 - Complete : Displayed for 3 seconds
 - Error : Flashes (Error displays 𐀀 See page 80.)

If there is an error:

- Press the STATUS button → Return to the normal screen.
- Press the SHUTTER dial → Return to the FILE MANAGE menu screen.
- To exit the FILE MANAGE screen:
 - Move the cursor (▶) to PAGE BACK and press the SHUTTER dial
 - or press the STATUS button.

■ Displaying the FILE MANAGE menu screen

Select the FILE MANAGE.. item on the TOP MENU screen.

■ Loading a menu settings file

Select the LOAD FILE.. item on the FILE MANAGE menu screen.

- Turn the SHUTTER dial, bring the cursor (▶) to SELECT and press the SHUTTER dial.
 - The file name setting area flashes.
- Turn the SHUTTER dial, select the file to load and press the SHUTTER dial.
- Turn the SHUTTER dial, bring the cursor (▶) to the LOAD item and press the SHUTTER dial.
 - EXECUTE flashes.
- With EXECUTE selected, press the SHUTTER dial to read the menu settings in the selected file.
 - If the current menu settings and the menu settings to be loaded have different video format settings, "REBOOT!" is displayed for 3 seconds, the camcorder turns off automatically and then turns on.

FILE MANAGE Menu Screen (Cont'd)

1. 2.

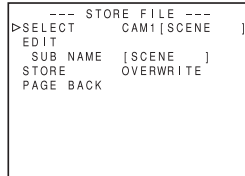

3.

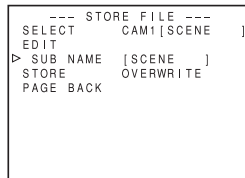

Settable Characters

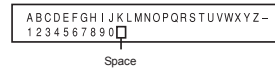

4.

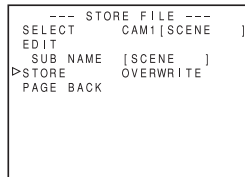

5. 6.

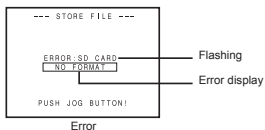
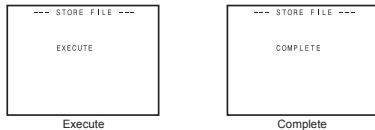

■ Saving settings

Select the STORE FILE.. item on the FILE MANAGE menu screen.

1. Turn the SHUTTER dial, bring the cursor (▶) to SELECT and press the SHUTTER dial.
 - The file name setting area flashes.

2. Turn the SHUTTER dial, select the file to save to, and press the SHUTTER dial.
 - Setting a SUB NAME

If you do not want to set a SUB NAME, go to Step 5..

3. Turn the SHUTTER dial, bring the cursor (▶) to SUB NAME and press the SHUTTER dial.
 - The first character in the file name flashes.

4. Turn the SHUTTER dial, select the character, and press the SHUTTER dial.
 - The second character in the file name flashes.

Repeat Step 4.. up through the eighth character.

5. Turn the SHUTTER dial, bring the cursor (▶) to the STORE item and press the SHUTTER dial.
 - EXECUTE (if the file already exists, "OVERWRITE") flashes.

6. With EXECUTE selected, turn the SHUTTER dial to save the menu settings to the selected file.

■ Error displays

- **NO CARD:**
No SD memory card is inserted. Insert an SD memory card.
- **NO FORMAT:**
The SD memory card is not initialized (formatted). Initialize (format) the SD memory card.
- **NO ACCESS:**
There is a problem with the SD memory card. Replace the SD memory card.
- **WRITE PROTECT:**
The SD memory card may be write-protected. Check that write-protection is disabled.
- **CARD FULL:**
The SD memory card does not have enough free space. Delete unwanted data or initialize (format) the card.
- **INVALID VIDEO FORMAT:**
A settings file for a video format that is not supported was called up. Settings files for video formats that are not supported cannot be called up.
- **READ ONLY FILE:**
Indicates a read-only file. Read-only files cannot be saved.

■ Resetting the menu settings to the factory settings

Select the RESET FILE.. item on the FILE MANAGE menu screen.

1. Turn the SHUTTER dial, bring the cursor (▶) to SELECT and press the SHUTTER dial.
 - The file name setting area for the file to be reset flashes.

2. Turn the SHUTTER dial, select the name of the file to reset, and press the SHUTTER dial.
 - CAM1, CAM2, CURRENT (current settings)

3. Turn the SHUTTER dial, bring the cursor (▶) to the RESET item and press the SHUTTER dial.
 - EXECUTE flashes.

4. With EXECUTE selected, turn the SHUTTER dial to reset the settings.

If the current menu settings and the factory settings have different video format settings, "REBOOT!" is displayed for 3 seconds, the camcorder turns off automatically and then turns on. When this happens, the SUB NAME initial value, "[SCENE]" is displayed.

MEMO

Even if CAM1 and CAM2 are reset, the current settings are not reset.

To reset the currently set values, select "CURRENT".

■ Initializing (formatting) an SD memory card

Before initializing (formatting) a card:

- ① Insert and remove the SD memory card with the power to the camcorder OFF.
- ② Disable write-protection on the SD memory card.
- ③ Check that an SD memory card has been inserted into the camcorder.

1. Turn the SHUTTER dial, bring the cursor (▶) to the FORMAT SD CARD item and press the SHUTTER dial.
 - CANCEL flashes.

2. Turn the SHUTTER dial, and when EXECUTE flashes, press the SHUTTER dial to initialize (format) the card.

If there is an error:

Check items ② and ③ in "Before initializing (formatting) a card".

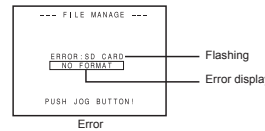
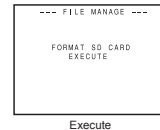
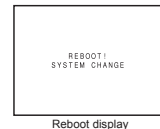
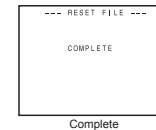
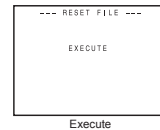
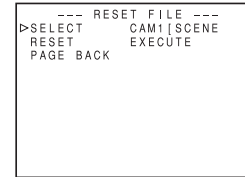

FEATURES OF THE CAMERA SECTION

How to Use Skin Detail

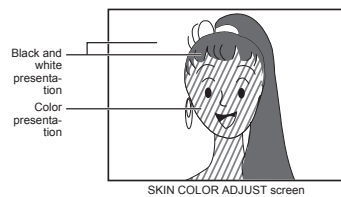
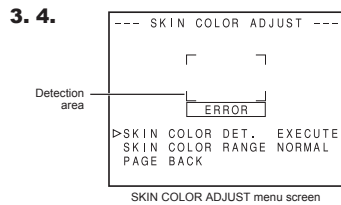
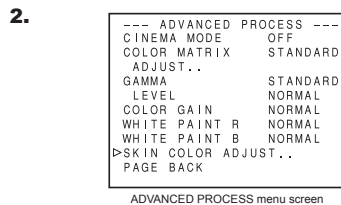
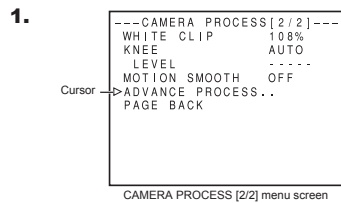
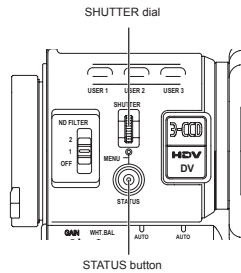

This function suppresses edge sharpening in the skin color areas of the video signal, enabling velvety, smooth skin tones.

Setting the skin detail function color and range

- Display the ADVANCED PROCESS menu screen. In menu setting procedure TOP MENU screen → CAMERA PROCESS [1/2] → CAMERA PROCESS [2/2] → Select ADVANCED PROCESS item.
- Turn the SHUTTER dial, bring the cursor (▶) to the SKIN COLOR ADJUST item and press the SHUTTER dial.
 - The SKIN COLOR ADJUST screen is displayed.
 - The entire screen becomes black and white, and only the areas recognized by the skin detail function are displayed in color.
- Move the cursor (▶) to the SKIN COLOR DET. item, press the SHUTTER dial and select EXECUTE to switch to skin color detection mode.
- Shoot so that the color area you want to detect within the detection area frame is input. To confirm the detection area, press the SHUTTER dial and set SKIN COLOR DET. to STOP.
 - The frame on the screen is the detection area for the skin detail function.
 - The color within the detection area is recognized as the color that the skin detail function will use.
 - If the color within the detection area is not recognized as the color that the skin detail function will use, "ERROR" is displayed on the screen.
- If you want to change the range of colors recognized with the skin color detection function, follow the steps below.
 - Turn the SHUTTER dial, bring the cursor (▶) to the SKIN COLOR RANGE item and press the SHUTTER dial.
 - The setting area flashes and can be changed.
 - Turn the SHUTTER dial up or down to widen or narrow the color range.
 - Set the range as you check the color display.
 - To confirm the color range, press the SHUTTER dial.
 - The setting returns to its lit state.
- To stop the SKIN COLOR ADJUST function, turn the SHUTTER dial, bring the cursor (▶) to the PAGE BACK item and press the SHUTTER dial.

FEATURES OF THE CAMERA SECTION

Using the Skin Detail Function

To use the skin detail function set on the SKIN COLOR ADJUST screen, select "ON" for the SKIN DETECT item on the CAMERA PROCESS [1/2] menu screen.

In addition, you can use the LEVEL item to set three levels of suppression of skin color area detail enhancement in the video signal. See page 65.

While the skin detail function operates, the "SD" indicator is displayed on the STATUS 0 and STATUS 1 screen in the viewfinder or LCD monitor.

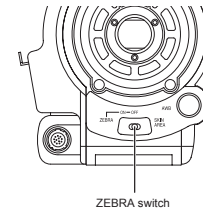
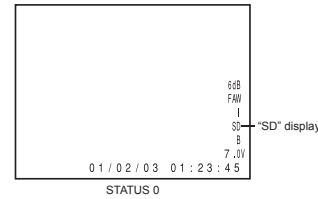

Confirming the color tone area adjusted with the Skin Detail function

When you push the ZEBRA switch on the front panel to "SKIN AREA", the skin detail function turns ON, and the color area adjusted with the skin detail function is displayed in color in the LCD monitor or viewfinder.

MEMO

When COLOR GAIN item on the ADVANCED PROCESS menu screen is set to "OFF", only the portion the skin detail function is working is displayed in skin color. See page 67.

FEATURES OF THE CAMERA SECTION

Outputting color bars

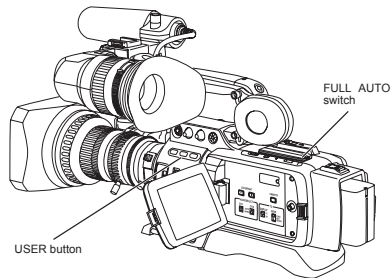

This camcorder can output three types of color bars, depending on the camera settings.

- NTSC standard : Outputs color bars compliant with the SMPTE standard.
- PAL standard : Outputs color bars compliant with the EBU standard.
- 16:9 screen : Outputs multi-format color bars.

To output color bars, make the following settings.

1. Turn the FULL AUTO switch to "OFF".
2. Set the BARS item on the CAMERA OPERATION menu screen to "ON". [Ⓜ] See page 64.
 - Color bars are output.

■ Outputting color bars using the USER buttons

1. Turn the FULL AUTO switch to "OFF".
2. Assign "BARS" to one of the USER1, 2 or 3 buttons. [Ⓜ] See "SWITCH MODE Menu Screen" on page 69.
3. Press the USER button to which "BARS" was assigned.
 - Color bars are output.

MEMO

- You can select whether to output an audio test signal during color bar output using the TEST TONE item on the AUDIO/MIC menu screen. [Ⓜ] See page 70.
- Color bars are not output when FULL AUTO mode is ON or in VTR mode.

OTHERS

Warnings and Responses

Warnings are displayed on the LCD monitor or the viewfinder if there was a mistaken operation, if the battery or tape is low, or if there is a problem on the VTR. In addition, if the tape or battery is low or the VTR has a problem, the tally lamp flashes (or lights) and an alarm is output from the monitor speaker or PHONES jack.

MEMO

This camcorder uses microcomputers. It may not operate properly if there is external static or interference. If this happens, turn the power off and then on again.

Display	Status	Action
60/30 24 INHIBIT CHANGE FRAME RATE MENU	The FRAME RATE item is set to 50/25, and a tape recorded in 60/30, 24 frame HDV format is played back or it is input into the IEEE1394 port in VTR mode.	Sets the FRAME RATE item on the VIDEO FORMAT menu screen to match the frames. [Ⓜ] See page 62.
60/30 INHIBIT CHANGE FRAME RATE MENU	The FRAME RATE item is set to 50/25, and a tape recorded in 60/30 frame DV format is played back or it is input into the IEEE1394 port in VTR mode.	
50/25 INHIBIT CHANGE FRAME RATE MENU	The FRAME RATE item is set to 60/30 or 24, and a tape recorded in 50/25 frame HDV/DV format or it is input into the IEEE1394 port in VTR mode.	
24 INHIBIT CHANGE FRAME RATE MENU	The FRAME RATE item is set to 50/25 and, a tape recorded in 24 frame DV format is played back or it is input into the IEEE1394 port in VTR mode.	
DV-60I INVALID! DV-24P INVALID! DV-24PA INVALID!	A tape recorded in DV-60I, DV-24P, or DV-24PA format was played back or input into the IEEE1394 connector in VTR mode on the E model.	The E model cannot play back tapes recorded in DV-60I, DV-24P or DV-24PA format or input into the IEEE1394 connector in VTR mode.
DV-50I INVALID! DV-25P INVALID!	A tape recorded in DV-50I or DV-25P format was played back or input into the IEEE1394 connector in VTR mode on the U model.	The U model cannot play back tapes recorded in DV-50I or DV-25P format or input into the IEEE1394 connector in VTR mode.
INVALID TAPE!	A computer data tape or a DVC PRO cassette was used.	Use a MiniDV videocassette.
LP TAPE INVALID!	Tried to play back a tape recorded in LP mode.	This camcorder cannot record or play back in LP mode.
NO DV SIGNAL	DV signal was not input.	Set the IEEE1394 switch to DV and input a DV signal.
NO HDV SIGNAL	HDV signal was not input.	Set the IEEE1394 switch to HDV and input an HDV signal.
COPY INHIBIT	Tried to record a copyguarded signal.	Cannot record a copyguarded signal.
REC INHIBIT	A tape that cannot be recorded (back switch is set to SAVE) was inserted.	Set the switch on the back of the cassette tape to REC.
NO TAPE	No videocassette tape is inserted.	Insert a cassette tape.
LOW VOLTAGE	Battery is low.	Charge the battery pack or replace it.
TAPE NEAR END	There are less than 3 minutes remaining on the tape (flashes only when recording).	To continue shooting, find a new tape or replace the tape.
TAPE END	Displayed when the tape ends.	Replace the tape.
CHANGE 1394 SWITCH	Recording or playback video format and the IEEE1394 setting is different when connected to the IEEE1394 port.	Set the IEEE1394 switch correctly, turn the power off and then on again.
SWITCH TO VTR MODE	Tried to use the FF or REW button in camera mode.	Press the CAM/VTR button to set VTR mode.
HEAD CLEANING REQUIRED	Displayed when the video head is dirty. (Head clogging was detected during an edit search in shooting mode as well as during playback and displayed.)	Clean with a special head cleaning tape. [Ⓜ] See page 7.
CLEANING TAPE!	Displayed when a head cleaning tape is inserted.	The display disappears when the head cleaning tape is removed.
COPY GUARD!	Tried to play back a copyguarded tape.	Cannot play back a copyguarded tape.
FAN MOTOR HOUR	Over the prescribed fan motor usage time.	Please contact your local dealer or JVC.
PUSH CASSETTE COVER	The videocassette cover is not firmly shut.	Lightly push the top center of the videocassette cover.

Warnings and Responses (Cont'd)

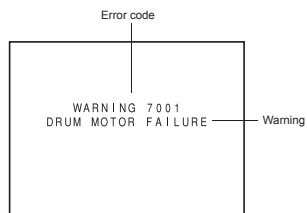

- Warning Indications for VTR Abnormalities**
 Should malfunctions occur during VTR operation, the unit self-diagnoses the cause and shows the diagnose together with an error code on the LCD monitor or in the viewfinder.

Error Code	Error Details	GY-HD100 Operation	Remedy		
0201 CONDENSATION ON DRUM	Indicates dew formation (condensation).	Operation stops. All operations are rejected.	Leave the unit with the power ON, until the indication disappears.		
3200 LOADING FAILURE	Tape cannot be loaded.		Switch the power OFF and then switch it back ON. However, the tape may be damaged depending on the circumstances. Please consult the person in charge of professional video equipment at your nearest JVC-authorized service agent.		
3300 UNLOADING FAILURE	Tape cannot be unloaded.				
4100 CASSETTE EJECT FAILURE	Irregularity with eject operation.				
5605 - 5609 DEFECTIVE TAPE	Tape is cut.	Operation stops.	Press the EJECT button to take out the cassette.		
5702 TAPE END DET. ERROR	Tape end sensor error.	Operation stops. All operations are rejected.	Switch the power OFF and then switch it back ON. However, the tape may be damaged depending on the circumstances. Please consult the person in charge of professional video equipment at your nearest JVC-authorized service agent.		
5802 TAPE BEGIN DET. ERROR	Tape beginning sensor error.				
7001 DRUM MOTOR FAILURE	Drum rotation error.				
7101 CAP MOTOR FAILURE	Capstan rotation error.				
7202 - 7203 SUPPLY REEL FAILURE	Supply reel rotation error.				
7302 - 7303 TAKE UP REEL FAILURE	Take up reel rotation error.				
7305 TAKE UP REEL FAILURE	Take up reel rotation error when unloading.				
8000 EMERGENCY TAPE!	Tape problem detected.				
TURN POWER OFF. TURN BACK ON LATER.	System error when power is turned on.			HDV/DV LED, VTR indicator and TALLY lamp flash. Only POWER switch operation is accepted.	Turn off the power and let the unit sit for sometime before turning it back on.

- TALLY lamp**
 Blinks when remaining battery power or tape is low. (Only in Camera mode)

Blinking Pattern	Remaining Battery/Tape
Slow blinking (once per sec.)	<ul style="list-style-type: none"> Remaining battery power is low. Remaining tape time is equivalent to less than 3 minutes.
Fast blinking (four times per sec.)	<ul style="list-style-type: none"> Tape has run out. Irregularity has occurred in the VTR.

- Alarm Sound**
 When remaining battery power becomes low, a warning sound is output from the monitoring loudspeaker and the PHONES jack. (In Camera mode only)
 When an irregularity occurs in the VTR, a warning sound is also output.

Whether or not alarm sound should be output and the volume level are selected with the ALARM VR LEVEL item on the OTHERS [1/2] menu screen.

- Depending on the alarm conditions, the warning indicators on the LCD monitor/viewfinder screen, the TALLY lamp, and alarm sounds appear as shown in the following table.

Alarm Indications on LCD Monitor/Viewfinder Screen	TALLY lamp	Alarm Sound	Condition
VTR alarm indication (Example) 7001 DRUM MOTOR FAILURE			Dew formation (condensation) or error has occurred in the VTR.
TAPE NEAR END			About 3 min. before tape end (displayed during recording).
TAPE END			Tape end (displayed during recording).
LOW VOLTAGE			Remaining battery power is low.

Display symbols
 : Blinking once per second.
 : Sound interrupted once per second.
 : Blinking four times per second.
 : Continuous sound.

Troubleshooting

Symptoms	Remedy
Power cannot be switched ON.	<ul style="list-style-type: none"> Is power supply connected correctly? Is battery pack recharged? Was the power turned ON immediately after being turned OFF? Wait at least 5 seconds before turning the power ON again once it has been turned OFF.
Recording is not possible.	<ul style="list-style-type: none"> Is the REC LOCK switch on the handle set to ON? Is the switch on cassette set to "REC"? If it is set to "SAVE", set it to "REC". The Camera mode has not been selected. (The VTR indicator does not light.) While the VTR indicator lights, press the MODE switch upward to turn on the CAM indicator.
Camera image does not appear on LCD monitor or in viewfinder.	<ul style="list-style-type: none"> The Camera mode has not been selected. (The VTR indicator does not light.) While the VTR indicator lights, camera image will not be output. Press the CAM/VTR switch upward to turn on the VTR indicator.
Image shown on LCD monitor or in viewfinder is dark or blurred.	<ul style="list-style-type: none"> Adjust the brightness of the LCD monitor or viewfinder screen. Is the ND filter knob set to 2? Is the iris closed? Is the shutter speed too fast? Is the viewfinder cable correctly connected?
Playback does not start when the play button is pressed.	<ul style="list-style-type: none"> In the Camera mode, is "STOP" indicated as the VTR operation mode indicator? When "STBY" is indicated, press the STOP button to display "STOP".
Cannot play back.	<ul style="list-style-type: none"> Is the PB TAPE item on the VIDEO FORMAT menu screen set to a setting other than AUTO? If this menu item and the tape format do not match, the tape cannot be played back.
Cannot input an HDV/DV signal.	<ul style="list-style-type: none"> Is the camcorder in VTR mode? (Is the VTR indicator lit?) Is the IEEE1394 switch set correctly?
Noise interferes with playback video.	<ul style="list-style-type: none"> Video head may be clogged with dirt. Clean head with the special head cleaning tape. [Ⓢ] See "Precautions for Use of Head Cleaning Tape" on page 7.
Sound is not output during playback.	<ul style="list-style-type: none"> Is the AUDIO SELECT item on the AUDIO menu screen set to CH3/4? To output the sound of the recording, set to CH1/2.
Noise appears when playing back a tape recorded on another unit.	<ul style="list-style-type: none"> When a tape recorded on another unit is played back or used for recording, this phenomenon may occur due to tracking errors.
The transient section between scenes recorded on other units and those recorded on the GY-HD100 may appear disturbed.	<ul style="list-style-type: none"> Are you trying to play back a tape recorded in HDV 1080i format? This camcorder cannot play back or output tape recorded in HDV 1080i format.
The front section's audio level control doesn't work.	<ul style="list-style-type: none"> Is the CH-1/CH-2 AUDIO SELECT switch set to "AUTO"? Is the FULL AUTO switch set to "ON"?
Cannot initialize (format) the SD memory card.	<ul style="list-style-type: none"> Is the SD memory card write-protected? [Ⓢ] See page 30.
Battery alarm is displayed even if a fully charged battery pack is put in.	<ul style="list-style-type: none"> Is the battery pack old?
Cassette cannot be ejected after the power is turned ON.	<ul style="list-style-type: none"> The capacity of the power supply may be insufficient. Check the power voltage.
Time code or user's bits data not displayed.	<ul style="list-style-type: none"> Is the TC/UB item on the LCD/VF [2/3] menu screen set to OFF? If so, set to ON.
The date and time are not displayed or recorded.	<ul style="list-style-type: none"> Is the DISPLAY item on the TIME/DATE menu screen set to OFF? Set to ON when the data should be displayed and recorded. Is the date and time setting made? [Ⓢ] See "Setting and Displaying the Date and Time" on page 36-37.

How to Display the Hour Meter

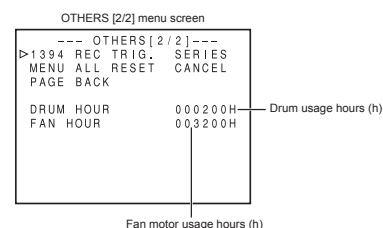

The drum and fan motor usage times are displayed in the DRUM HOUR item and the FAN HOUR items on the OTHERS [2/2] menu screen as the hour meters on this camcorder. Use as an estimate for regular maintenance. [Ⓢ] See page 7.

- Turn the POWER switch ON.
- Press the STATUS button for at least 1 second to display the TOP MENU screen.
- Turn the SHUTTER dial, select the OTHERS. item, and press the SHUTTER dial. The OTHERS [1/2] menu screen is displayed.
- Select the NEXT PAGE item on the OTHERS [1/2] menu screen and press the SHUTTER dial. The OTHERS [2/2] menu screen is displayed.
 - OTHERS [2/2] Menu Screen
 - DRUM HOUR item : Displays the drum usage hours.
 - FAN HOUR item : Displays the fan motor usage hours.
- To return to the normal screen display, do one of the following:
 - Press the STATUS button.
 - or
 - Return to the TOP MENU screen, select the EXIT item on the TOP MENU screen and press the SHUTTER dial.

Information for Users on Disposal of Old Equipment



Attention:

This symbol is only valid in the European Union.

[European Union]

This symbol indicates that the electrical and electronic equipment should not be disposed as general household waste at its end-of-life. Instead, the product should be handed over to the applicable collection point for the recycling of electrical and electronic equipment for proper treatment, recovery and recycling in accordance with your national legislation.

By disposing of this product correctly, you will help to conserve natural resources and will help prevent potential negative effects on the environment and human health which could otherwise be caused by inappropriate waste handling of this product. For more information about collection point and recycling of this product, please contact your local municipal office, your household waste disposal service or the shop where you purchased the product. Penalties may be applicable for incorrect disposal of this waste, in accordance with national legislation.

(Business users)

If you wish to dispose of this product, please visit our web page www.jvc-europe.com to obtain information about the take-back of the product.

[Other Countries outside the European Union]

If you wish to dispose of this product, please do so in accordance with applicable national legislation or other rules in your country for the treatment of old electrical and electronic equipment.

Specifications

[General]

Power requirements	: DC 7.2 V, \approx 2.3 A
Power consumption	: Approx. 16.5 W (in the Record mode)
Dimensions	: 235 (W) \times 232 (H) \times 341 (D) mm
Mass	: 3.3 kg (7.3 lbs.) (including lens (Th16 \times 5.5BRMU), viewfinder, battery pack, microphone and tape)
Temperature	
Operating	: 0°C to 40°C (32°F to 104°F)
Storage	: -20°C to 60°C (-4°F to 140°F)
Humidity	
Operating	: 30% to 80% RH
Storage	: 85% RH or less

[Camera section]

Image pickup device	: 1/3" interline-transfer CCDs
Color separation	: F1.4, 3-color separation prism optical system
Number of total pixels	: Approx. 1,110,000 pixels
Color bars	: SMPTE/EBU type Sync system: Internal sync (built-in SSG)
Lens mount	: 1/3" bayonet system
ND filter	: 1/4ND, +1/16ND
Gain	: 0, 3, 6, 9, 12, 15, 18 dB, ALC
Electronic shutter	
Standard value	: 59.94 Hz (GY-HD100U)/50 Hz (GY-HD100E/HD101E)
Fixed values	: 7.5 - 10,000 Hz, 11 steps (HDV HD30p/HDV SD60p/DV 60i mode: GY-HD100U only), 6.25 - 10,000 Hz, 11 steps (HDV HD25p/HDV SD50p/DV 50i mode: GY-HD100E/HD101E only), 6 - 10,000 Hz, 12 steps (HDV HD24p/DV 24p: GY-HD100U only), 6.25 - 10,000 Hz, 11 steps (DV 25p: GY-HD100E/HD101E only)
Variable scan	: 60.19 - 1,998.0 Hz (HDV HD30p/HDV 60p), 50.20 - 1,973.6 Hz (HDV HD25p/HDV SD50p/DV 50i), 48.11 - 1,998.0 Hz (HDV 24p/DV 24p: GY-HD100U only)
Dynamic range	: 300% or more

[VTR section]

Video	
Recording format	: 720/24p, 720/25p, 720/30p, 576/50p, 480/60p (GY-HD100U/HD100E/HD101E), 480/24p, 480/60i (GY-HD100U), 576/25p, 576/50i (GY-HD100E/HD101E)
Video Format:	
[HDV]	
Video signal record-ing format	: HDV720p format, 8-bit, 19.7 Mbps
Compression	: MPEG-2 video (profile & level: MP@H-14)
[DV]	
Video signal record-ing format	: DV format, 8-bit, 25 Mbps
Compression	: DV compression, 4:1:1 (NTSC)/4:2:0 (PAL)
Audio:	
[HDV]	
Audio signal record-ing format	: MPEG1 Audio Layer II
[DV]	
Audio signal record-ing format	: 16-bit (locked audio), 48 kHz PCM for 2 channels or 12-bit, 32 kHz PCM for 4 channels
Usable tape	: MiniDV tape
Tape speed	: 18.8 mm/sec.
Record/play time	: 63 minutes (with an M-DV63PROHD tape)

[Connectors]

Analog composite output	
	: 1.0 V (p-p), 75 ohms, unbalanced (RCA)
Analog component output	
Y	: 1.0 V (p-p), 75 ohms, unbalanced (RCA)
Pb/P _r	: 0.7 V (p-p), 75 ohms, unbalanced (RCA)
Audio inputs	
Mic	: -60 dBs, 3 kohms, balanced (XLR), +48 V output for phantom power supply
Line	: +4 dBs, 10 kohms, balanced (XLR)
Audio outputs	: -8 dBs, low impedance, unbalanced (stereo mini-jack)
Earphone jack	: -17 dBs to -60 dBs, 8-ohm impedance (stereo mini-jack \times 2)
IEEE1394 connector	: 6-pin

[ACCESSORIES]

Lens	: 1
Microphone	: 1
AC Adapter	: 1
Battery pack	: 1
DC cable	: 1 Approx. 2 m
Power cord	: 1 Approx. 2 m (U model only)
Power cord	: 2 Approx. 2 m (E model only)
Core Filter	: 2
Clamp Filter	: 2
Audio cable	: 1
SD memory card	: 1
Instruction Manual	: 1
Warranty Card	: 1
(USA and Canada only)	

[AC ADAPTER SECTION]

Power	: USA and Canada: AC 120 V, 60 Hz European countries: AC 220 V to 240 V, 50 Hz/60 Hz Other countries: AC 110 V to 240 V, 50 Hz/60 Hz
Power consumption	: 23 W
Output power	: DC 7.2 V, 1.2 A (charge) DC 7.2 V, 2.3 A (VTR)
Operating temperature	: 0°C to 40°C (32°F to 104°F) [when charging, 10°C to 35°C (50°F to 95°F)]
Dimensions	: 122 (W) \times 51 (H) \times 92 (D) mm (4-4/5" \times 2" \times 3-3/5")
Mass	: Approx. 280 g (Main body only)

For details, consult your JVC dealer.

Design and specifications are subject to change without notice.

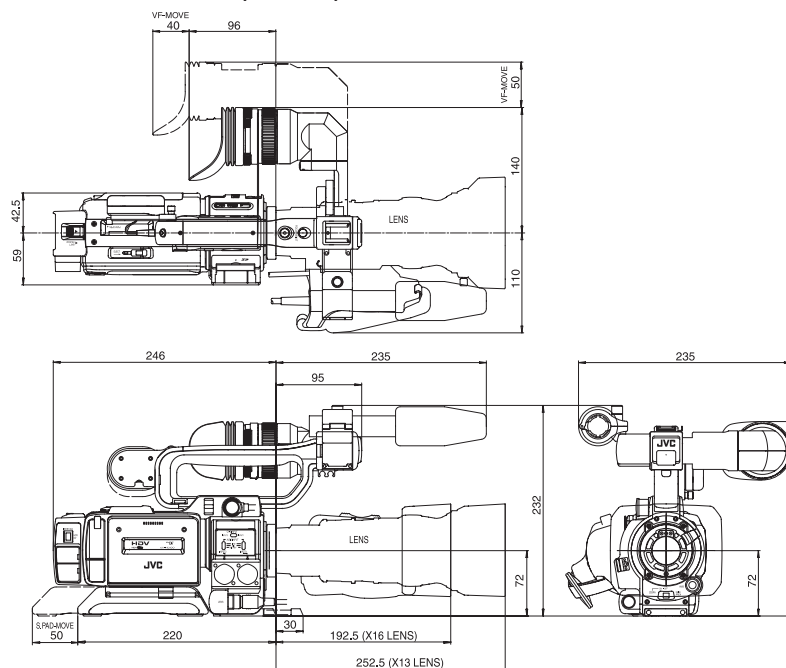
EXTERNAL DIMENSIONS (unit: mm)

* Design and specifications are subject to change without notice